



King of The Sea  
**MAREX**

*Our quality*

*Your safety and boat pleasure*

**MAREX**  
**CONGRATULATES YOU**  
**WITH YOUR NEW**  
**Marex 375**

You are now the owner of quality product from MAREX. Your boat is built by the highest standards of safety and quality for your safety and pleasure.

The owner's manual is written so that you as a boat owner can have the best possibilities to get experienced with the boat and its functions. The owner's manual contains important information about handling, safety, systems, equipment mounted or delivered with the boat. You will also find useful information about use and maintenance.

It is recommended that you make yourself acquainted with the boats maneuvering ability and properties before you start to use it, regardless of previous boating experience. Your local dealer can assist you in finding an instructor or boating school.

Please study the owner's manual carefully before using the boat.

**Producer:**

**MAREX Boats UAB**

Eglių g. 1, Ilgakiemio km., Garliavos sen.,

LT-53288 Kauno r.,

Lithuania

Phone: 00370 37 261 500

Fax: 00370 37 261 700

E-mail: office@marex.lt





## Contents

<b>1.0 GENERAL INTRODUCTION.....</b>	<b>4</b>
1.1 INSTALLED EQUIPMENT .....	6
1.2 SYMBOLS USED IN THE OWNER'S MANUAL .....	6
1.3 CONSTRUCTION CATEGORIES.....	7
1.4 ABOUT THIS OWNER'S MANUAL.....	8
<b>2.0 TECHNICAL DATA .....</b>	<b>9</b>
2.1 GENERAL TECHNICAL DATA .....	9
2.2 HULL .....	9
2.3 WINDSCREEN.....	11
2.4 ENGINE.....	11
2.5 ELECTRIC SYSTEM.....	11
2.6 CAPACITIES .....	12
<b>3.0 SAFETY .....</b>	<b>13</b>
3.1 GENERAL .....	13
3.2 FIRE .....	14
3.2.1 PORTABLE FIRE EXTINGUISHER .....	14
3.2.2 AUTOMATIC FIRE EXTINGUISHER .....	15
3.2.3 FIRE ALARM .....	17
3.3 COOKER AND OVEN.....	17
3.3.1 GAS INSTALLATION AND LEAKAGE TEST INSTRUCTION.....	20
3.4 ELECTRIC SYSTEM.....	21
3.5 BATTERIES .....	21
3.6 ENGINE ROOM .....	22
3.7 FUEL TANK.....	22
3.8 THROUGH HULL LEADS - UNDER THE WATERLINE.....	23
3.8.1 CLOSING VALVE - SEAWATER INLET FOR THE TOILET SYSTEM.....	23
3.8.2 CLOSING VALVE - BLACKWATER OUTLET.....	24
3.8.3 CLOSING VALVE - SEAWATER INLET FOR ENGINE COOLING .....	25
3.9 STABILITY AND BUOYANCY .....	25
3.10 SAFETY EQUIPMENT .....	26
3.11 EMERGENCY EXITS.....	27
3.12 EMERGENCY STEERING.....	27
<b>4.0 DRAWINGS AND TECHNICAL DESCRIPTIONS OF THE BOAT .....</b>	<b>28</b>
4.1 ARRANGEMENT AND EXTERIOR DRAWINGS .....	28
4.2 TECHNICAL SYSTEMS.....	28



4.2.1 DRAWINGS OF THE TECHNICAL SYSTEMS .....	28
4.2.2 PICTURES AND DESCRIPTION OF INSTALLED COMPONENTS.....	29
4.3 FUEL SYSTEM .....	29
4.4 DRAINING SYSTEM.....	31
4.5 LENSING SYSTEM.....	32
4.5.1 MANUAL LENSING SYSTEM .....	32
4.5.2 AUTOMATIC LENSING SYSTEM .....	32
4.6 FRESH WATER SYSTEM .....	34
4.7 SEPTIC SYSTEM/BLACK WATER SYSTEM.....	36
4.8 ELECTRIC SYSTEM.....	39
4.9 EXHAUST SYSTEM .....	41
4.10 VENTILATION SYSTEM FOR THE ENGINE .....	42
4.11 FIRE EXTINGUISHING SYSTEM.....	42
<b>5.0 OPERATION .....</b>	<b>44</b>
5.1 STARTING OF THE ENGINE .....	44
5.2 BATTERIES (LEAD ACCUMULATORS) .....	45
5.3 FUSE PANEL & CONNECTION SCHEMES .....	47
5.4 MAIN SWITCH PANEL .....	47
5.5 WINDSCREEN WIPERS .....	48
5.6 DASHBOARD INSTRUMENTS INSTALLATION ACCESS.....	48
5.7 ELECTRIC SYSTEM.....	49
5.8 SEPTIC SYSTEM .....	52
5.9 OPERATING OTHER EQUIPMENT .....	55
5.9.1 COOKER AND OVEN .....	55
5.9.2 DEFROSTER.....	55
5.9.3 DIESEL HEATER.....	56
5.10 MANOEUVRING OF THE BOAT .....	57
5.11 HINTS AND ADVICES .....	60
5.11.1 LIFTING AND STORAGE IN A “CRADLE” .....	60
5.11.2 BOAT TRANSPORT .....	61
5.11.3 BOAT MOORING.....	61
5.11.4 BOAT ANCHORING .....	62
5.11.5 TOWING AND BEING TOWED.....	62
<b>6.0 PERIODIC MAINTENANCE.....</b>	<b>63</b>
6.1 MAINTENANCE OF THE HULL.....	63
6.1.1 BEFORE PLACING THE BOAT ON WATER.....	63
6.1.2 BEFORE WINTER STORAGE .....	63



6.1.3 NORMAL MAINTENANCE .....	64
6.2 MAINTENANCE OF THE TEAK DECK .....	64
6.3 MAINTENANCE OF THE ENGINE AND THE DRIVE .....	64
6.4 MAINTENANCE OF THE STEERING SYSTEM .....	64
6.5 MAINTENANCE AND CONTROLLING OF THE ELECTRIC SYSTEM .....	65
6.6 MAINTENANCE OF THE GAS SYSTEM .....	66
6.7 MAINTENANCE OF THE FUEL SYSTEM.....	67
6.8 MAINTENANCE OF THE LENSING SYSTEM .....	68
6.9 MAINTENANCE OF THE FIRE EXTINGUISHERS .....	69
6.10 MAINTENANCE OF THE FRESH WATER TANKS .....	69
6.11 MAINTENANCE OF THE FENDER LIST .....	69
<b>7.0 PREPARING FOR THE SEASON.....</b>	<b>70</b>
7.1 GENERAL PREPARATION .....	70
7.2 PREPARING THE ENGINE AND THE DRIVE .....	70
7.3 PREPARING THE STEERING .....	70
7.4 OTHER EQUIPMENT .....	71
7.5 REMOVING RUST/CORROSION.....	71
<b>8.0 WINTER STORAGE PREPARATION.....</b>	<b>72</b>
8.1 BATTERIES .....	72
8.2 HULL .....	72
8.3 STEERING SYSTEM .....	72
8.4 SEPTIC SYSTEM .....	73
8.5 FRESHWATER SYSTEM .....	73
8.6 ENGINE AND DRIVE .....	73
<b>9.0 ENVIRONMENTAL ISSUES .....</b>	<b>74</b>
<b>10.0 POSITIONS OF THROUGH HULL AND DECK FITTINGS .....</b>	<b>75</b>
10.1 STARBOARD SIDE .....	75
10.2 PORT SIDE .....	76
10.3 TOP VIEW - HULL BOTTOM.....	77
10.4 TOP VIEW - DECK .....	77
<b>11.0 OVERVIEW .....</b>	<b>78</b>
<b>ANNEX 1: A CHECKLIST OF ALL NECESSARY ACTIONS BEFORE USE .....</b>	<b>80</b>
<b>ANNEX 2: A CHECKLIST OF ALL NECESSARY ACTIONS AFTER THE WINTER STORAGE.....</b>	<b>81</b>



## 1.0 GENERAL INTRODUCTION

This manual has been compiled to help you to operate your craft with safety and pleasure. It is not a course on boating safety or seamanship. If this is your first boat, or if you are changing to a type of boat you are not familiar with, for your own comfort and safety, please ensure that you obtain handling and operating experience before “assuming command” of the boat.

Ensure that the anticipated wind and sea conditions will correspond to the design category of your boat, and that you and your crew are able to handle the boat in these conditions. Even when your boat is categorized for them, the sea and wind conditions corresponding to the design categories A, B and C range from severe storm conditions for category A, to strong conditions for the top of category C, open to the hazards of a freak wave or gust. These are therefore dangerous conditions, where only a competent, fit and trained crew using a well maintained boat can satisfactorily operate.

This owner's manual is not a fully detailed maintenance or trouble-shooting guide. In the case of difficulty, refer to the boat builder or his representative.

Always use trained and competent people for maintenance, fixing or modifications. Modifications that may affect the safety characteristics of the boat shall be assessed, executed and documented by competent people. The boat builder cannot be held responsible for modifications that have not been approved.

Always maintain your boat properly and make allowance for the deterioration that will occur in time and as a result of heavy use or misuse of the boat.

Any boat, no matter how strong it may be, can be severely damaged if not used properly. This is not compatible with safe boating. Always adjust the speed and direction of the boat to sea conditions.

The boat should have appropriate safety equipment (lifejackets, harness, etc.) on board according to the type of boat, weather conditions, etc. This equipment is mandatory in some countries. The crew should be familiar with the use of all safety equipment and emergency manoeuvring (man overboard recovery, towing, etc.), sailing schools and clubs regularly organize drill sessions.

All persons should wear a suitable buoyancy aid (life jacket/personal floatation device) when on deck. Note that, in some countries, it is a legal requirement to wear a buoyancy aid that complies with their national regulations at all times.

The owner's manual is written according to the following standard:  
EN-ISO-10240:2004.



MAREX 375

Type: **Marex 375**

Construction category: **B**

Approval: **EC TYPE EXAMINATION BY DET IMSI (INTERNATIONAL MARINE CERTIFICATION INSTITUTE)**  
**Certificate number:** \_\_\_\_\_  
See copy enclosed in divider number 5.

The boat's CIN number (Craft Identification Number) is engraved aft of the boat, under the fender-list, on the starboard side.



Picture 1: The boat's CIN number location

**PLEASE KEEP THIS MANUAL IN A SECURE PLACE, AND HAND IT OVER TO THE NEW OWNER IF YOU SELL THE BOAT.**



MAREX 375

## 1.1 INSTALLED EQUIPMENT

Divider number 4 contains a list of installed equipment in your boat.

## 1.2 SYMBOLS USED IN THE OWNER'S MANUAL

### **DANGER:**

The “Danger” warnings in the owner’s manual or in the installed component **MUST** be followed to avoid personal injury or serious material damage.

### **WARNING:**

The warnings must be followed to avoid damage on boat or on equipment.

### **CAUTION:**

This should be remembered to avoid damage on persons or equipment.

### **DESCRIPTION:**

This is the description of location of the equipment or component.

### **INSTRUCTION MANUAL:**

Read the separate instruction manual/user manual for this equipment. This is placed in the “User bag” enclosed in the boat.





MAREX 375

## 1.3 CONSTRUCTION CATEGORIES

EU-directive 94/25/EC defines the following construction categories:

**A. OCEAN:** This craft is designed for extended voyages where conditions may exceed wind force 8 (Beaufort scale) and significant wave heights of 4 m and above but excluding abnormal conditions, and vessels largely self-sufficient.

**B. OFFSHORE:** This craft is designed to operate in winds up to Beaufort force 8 and the associated wave heights (significant wave height up to 4 m). Such conditions may be encountered on offshore voyages of sufficient length, or on coastal waters when unsheltered from the wind and waves for several dozens of nautical miles. These conditions may also be experienced on inland seas of sufficient size for the wave height to be generated.

**C. INSHORE:** This craft is designed to operate in winds up to Beaufort force 6 and the associated wave heights (significant wave height up to 2 m). Such conditions may be encountered in exposed inland waters, in estuaries, and in coastal waters in moderate weather conditions.

**D. SHELTERED WATERS:** This craft is designed for voyages on sheltered coastal waters, small bays, small lakes, rivers and canals when conditions up to, and including, wind force 4 and significant wave heights up to, and including, 0,3 m may be experienced, with occasional waves of 0,5 m maximum height, for example from passing vessels.

*Boats in each category must be designed and constructed to withstand these parameters in respect of stability, buoyancy, and other relevant essential requirements, and to have good handling characteristics.*

### **CAUTION:**

**THE ACTUAL USE OF THE BOAT IS ON OWN RISK. READ ALL THE WARNINGS  
IN THE OWNER'S MANUAL.**





MAREX 375

## 1.4 ABOUT THIS OWNER'S MANUAL

- ✓ This owner's manual is a part of the documentation that follows the boat.
- ✓ Included in the boat is a "user bag" that contains the owner's manual and separate instructions.



Picture 2: The user bag

- ✓ This "user bag" is considered a part of the boat and must be included in the boat for future owners.
- ✓ Marex is continuously developing the quality of its products. This owner's manual contains information updated at the time of the print of this book and may therefore deviate from your boat. Please contact Marex or your local dealer if questions regarding the owner manual appear.
- ✓ This owner's manual is adjusted to a standard equipped boat.
- ✓ Many Marex boats are custom made. Equipment that is not of significant importance to the safety or stability of the boat is not incorporated in this owner's manual.



MAREX 375

## 2.0 TECHNICAL DATA

Part of the information is given on the builder's plate fixed on the craft. A full explanation of this information is given in the relevant sections of this manual.

### 2.1 GENERAL TECHNICAL DATA

Boat type: **Marex 375**  
Construction category: **B**

### 2.2 HULL

Type	Measurement	Unit
Length over all, including bowsprit and platform (LOA)	11,99	m
Length of hull (Lh)	11,90	m
Length hull waterline (LWL)	9,68	m*
Transport height without lantern mast and mounted extra equipment (Transport height excluding the rudder and propeller)	3.49	m*
Transport height without lantern mast and mounted extra equipment (Transport height including the rudder, propeller and propeller protector)	3.83	m
Total height from bottom to top lantern mast, including flagpole	4.3	m*
Height from the waterline (Sailing height) with lantern mast, including flagpole	3.71	m*
Height from the waterline (Sailing height) with lantern mast, excluding flagpole	3.71	m*
Height from the hulls keel to the top of the lantern mast, including top lantern	4.3	m
Height of the mounted and removable lantern mast	0.81	m
Marex cradle height	0.10	m
Beam excluding fender list BOA	3.45	m
Beam including fender list BOA	3.49	m
Beam of the boat waterline BWL	3.075	m
Displacement of empty boat (twin engine)	7400	kg *
Maximum recommended load**	2400	kg
Maximum allowed displacement***	9800	kg

- m\*/ kg\* standard boat and weight with twin engine installation (2 x Volvo D4)  
- \*\* Maximum recommended load includes the weight of all persons onboard, all provisions and personal effects, any equipment not included in the light craft mass, cargo (if any) and all consumable liquids (water, fuel, etc.).  
- \*\*\* see section 2.5 Capacities for detailed loading condition.



# MAREX 375

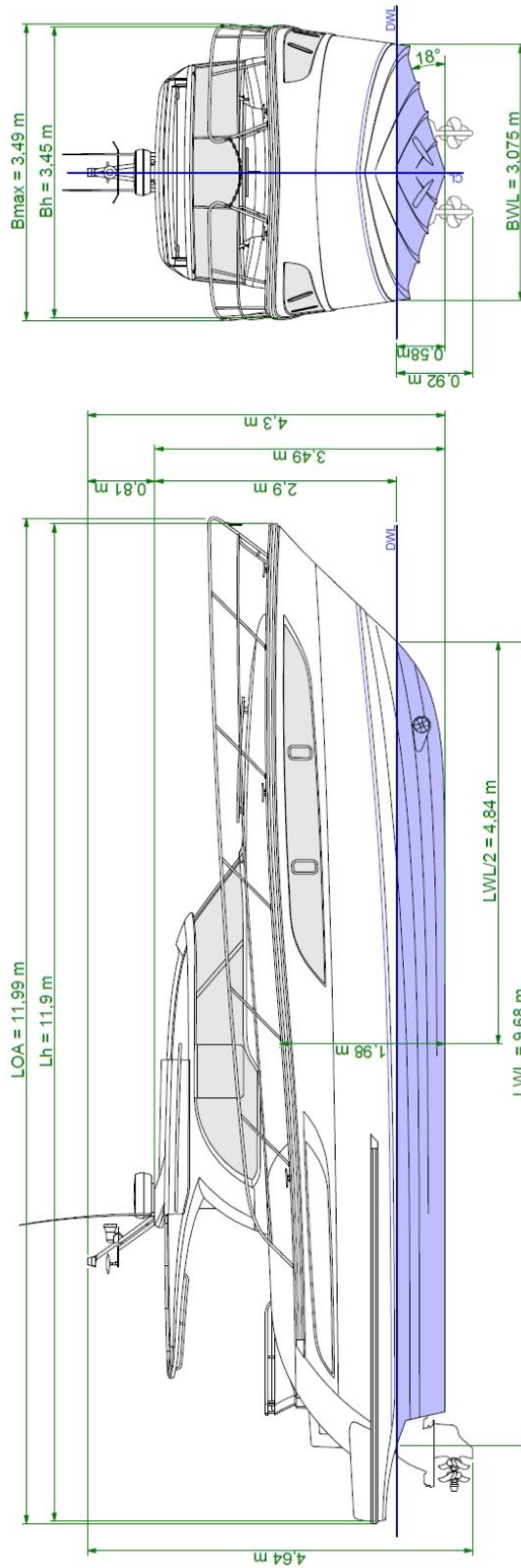

Figure 1: Main dimensions



MAREX 375

## 2.3 WINDSCREEN

Defects allowed:

1. Scratches up to 30 mm in length, no more than 1 pcs on one glass.
2. Damages smaller than 0.5mm, no more than 3 pcs on one glass.
3. Damages smaller than 2mm in diameter, within 30 mm of the edge. No more than 3pcs on one glass.

## 2.4 ENGINE

Engine type: **Twin Marine Diesel, 2 x 221 kW (300hp) 370hp max.**

Propulsion type: **Twin Z drive**

## 2.5 ELECTRIC SYSTEM

Voltage: **12V DC & 230V AC**

Starter battery: **2 x 100 Ah**  
**Optional: AGM Starter battery 2x 95 Ah**

Service batteries: **4 X 95 Ah**



## 2.6 CAPACITIES

Fuel tank:	<b>700 litres*</b> (All of its capacity may not be usable according to trim and loading and 20% reserve should be kept.)
Water tank:	<b>350 litres* - 2 x 175 litres</b> (All of its capacity may not be usable according to trim and loading.)
Septic tank:	<b>150 litres*</b>
Lens pump – manual: Engine room: Front cabins:	<b>23.6 L/min</b> <b>23.6 L/min</b>
Lens pump – electric: Engine room: Front cabins (optional):	<b>54.25 L/min</b> <b>54.25 L/min</b>
Max load incl. 10 persons (adults), full tanks and luggage:	<b>2400 kg</b>
Max load incl. 10 persons (adults) and luggage (as shown on the producer plate):	<b>1000 kg</b>
Max recommended number of persons:	<b>10 persons (adults)</b>

\* Total weight of liquids (fuel, water, grey & septic tank), when all permanently installed tanks are full, is 1400 kg.

 **WARNING:**

**Do not exceed the maximum recommended number of persons. Regardless of the number of persons on board, the total weight of persons and equipment must never exceed the maximum recommended load. Always use the seats/seating spaces provided.**

 **WARNING:**

**When loading the craft, never exceed the maximum recommended load. Always load the craft carefully and distribute loads appropriately to maintain design trim (approximately level). Avoid placing heavy weights high up.**



## 3.0 SAFETY

We summarize the important information for safety aboard. A great deal of the information will be repeated later in the owner's manual, but Marex signify the importance for you as a customer and user of the boat that this information must be easy accessible in a stressed situation.

**What is described here should be carefully studied by the user!**

### 3.1 GENERAL

**⚠ WARNING:**

**Never:**

- ✓ let objects block the emergency exits (doors and hatches).
- ✓ let objects hinder access to the fuel stop valve, lens pumps and electrical switches.
- ✓ let objects hinder access to fire extinguishers.
- ✓ use gas lights.
- ✓ change any of the boats technical systems – especially the gas fuel and electrical systems.
- ✓ fill the fuel tank while the engine is running or while the cooker or heater is in use.
- ✓ smoke when handling fuel.
- ✓ use the rails to pull anything after the boat.
- ✓ use the rails as mooring.
- ✓ place fenders at the exhaust outlets for heater and cooker.

**Always:**

- ✓ inspect the whole boat, particularly the engine room for leakages before every start-up of the engine.
- ✓ have cabin doors closed during sailing. The weight of the doors can make the doors slam. Also close all port lights and windows during rough weather conditions or while planning.
- ✓ hold lensing pump free from impurities.
- ✓ check for leakage of the fuel system.
- ✓ check the fuel level.



## 3.2 FIRE

### **⚠ DANGER:**

#### **📖 INSTRUCTION MANUAL**

- Portable fire extinguisher (2 kg, type ABE class II - powder apparatus) is located at the step near the helm position.
- The engine room has an automatic fire extinguisher system with auto discharge and auto stop of the engine. This extinguisher has an indicator located by the dashboard.

### **⚠ WARNING:**

- Do not mount curtains or other fabrics over or close to any cooker or open flame sources. It is prohibited to store flammable material in the engine room! If non-flammable material is kept in the engine room it must not block access or risk contact with hot engine parts.
- Do not store equipment containing petrol (outboard engines, tanks, petrol generators, etc.) in compartments that are not designed for this purpose.

### **When fire gets out of control, you have to:**

- take on the emergency vests.
- send emergency signals by radio or chart plotter, signal lights or telephone.
- evacuate the boat.

## 3.2.1 PORTABLE FIRE EXTINGUISHER

#### **📖 INSTRUCTION MANUAL**

See the separate user manual in the “user bag”. Read the instructions of the apparatus and be prepared for an emergency.



Picture 3: Location of the portable fire extinguisher (Sitting Group)





MAREX 375

**⚠ WARNING:**

- Do not lift or transport the extinguisher holding the sensor valve.
- Do not drop the extinguisher.
- Keep the extinguisher out of reach from the children.
- After a discharge – REPLACE the extinguisher with a new one.

**📖 INSTRUCTION MANUAL**

All fire extinguishers must be controlled one time per year by qualified personnel.

The user/owner is responsible for:

- That the extinguisher is controlled by qualified personnel at recommended times.
- That the extinguisher is replaced with working equipment.
- Inform the passengers about:
  - ✓ the location and use of the fire extinguisher.
  - ✓ the location of the emergency exits.
- Assure that fire extinguisher is easy accessible.

### 3.2.2 AUTOMATIC FIRE EXTINGUISHER

**📖 INSTRUCTION MANUAL**

Read the manual for Sea-Fire, enclosed in the “user bag”.

Boats with engines larger than 120 kW (163 Hp), are equipped with a permanent fire extinguisher in the engine room.

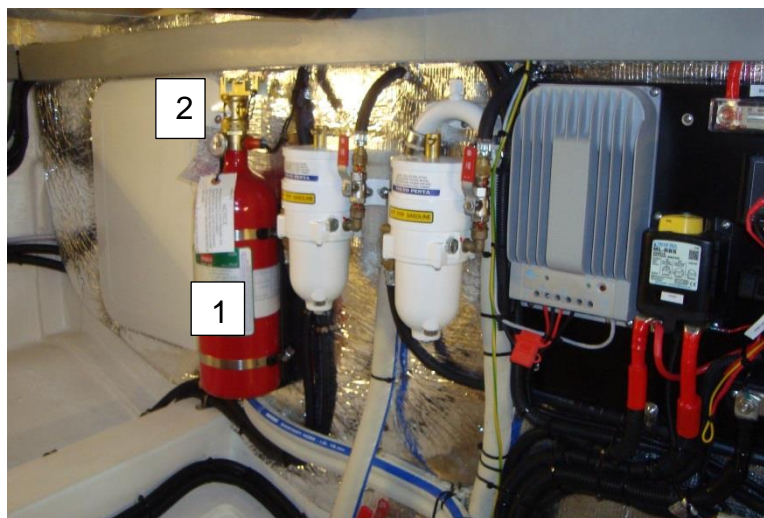

Picture 4: Automatic fire extinguishing system (1) in the Engine room with visible volume level indicator (2)



The fire extinguisher in the engine room automatically discharges by temperatures over 74° C. Indicator by the helmsman's position informs if the extinguisher has been discharged. When automatic discharge of the content happens, the engine stops automatically!



Picture 5: Fire extinguisher indicator

When the ignition is on, the lamp indicator will light as long as the system is ready to be discharged. After a discharge the lamp will no longer light.



Picture 6: The fire extinguisher lamp indicator at the dashboard (1)

**⚠ CAUTION**

Your boat has an automatic fire extinguishing system in the engine room that uses FM200 as an active component.



### **PROCEDURE WHEN AUTOMATIC DISCHARGE HAPPENS:**

- When automatic discharge of the content happens, you have to turn off the main switches.
- Then evacuate the cabins.
- Let the automatic extinguisher in the engine room work for several minutes.
- Grab the manual fire extinguisher and release the safety pin.
- **After discharge always ventilate before entering the engine room. When you open the engine hatches, have the manual extinguisher ready and be alert.**
- Control the engine room for remaining fire.

### **⚠ DANGER:**

The engine room has a non-removable installed system. The content of the extinguisher can cause serious respiration problems or even death.

### **3.2.3 FIRE ALARM**

Marex is one of few producers that mount a fire alarm as standard equipment. We prioritize your safety and have mounted several fire alarms, on the front cabin ceiling, hallway ceiling and in the cockpit near the main sliding door.

## **3.3 COOKER AND OVEN**

Standard equipment includes a gas cooker.

### **📖 INSTRUCTION MANUAL**

- Read user manuals and installation instructions.

### **⚠ DANGER:**

Remember that the cooker uses gas and oxygen, to burn!

### **⚠ WARNING:**

- The cooker must not be used as a heating oven.
- Never leave the boat with gas devices in use.
- Never start the cooker without checking the system.

### **⚠ CAUTION**

- Avoid contact of materials with naked flames and other hot areas.
- Do not use detergents containing ammoniac.



- The gas bottle is located in the bathing platform bench storage. The compartment where the gas bottle is kept is drained out under the bathing ladder cover.



Picture 7: Gas bottle storage with the pressure reduction valve (1)

The pressure reduction valve must never come in contact with saltwater; when it does, it will start to corrode. If any corrosion is seen it must be changed before you use the gas system. The pressure reduction valve must be controlled often and should be replaced every year.

The gas closing valve is located on aft deck in the small bench.



Picture 8: Gas closing valve for cooker and oven (1)



MAREX 375

➤ ***If the gas cooker is installed:***

- ✓ Close the closing valves to the cooker and the valve in the compartment on the bathing platform when the cooker is not in use.
- ✓ Close the valves before changing the gas bottles.
- ✓ Close the valves immediately in an emergency.
- ✓ Make sure that the valves are closed before opening the safety cap on the bottle.

- **Do not block the access to any components of the gas system.**
- Keep the valves for empty gas bottles closed and disconnected. Keep hatches closed and all plugs in place. Store the spare gas bottle in ventilated rooms or in a gas tight container with certified ventilation.
- Never use the gas boxes for storing of other equipment.
- Do not use the gas system if the boat is not in balance.

**⚠ WARNING:**

**Fuel burning devices with open flame consume oxygen in the cabin and release products of combustion into the boat. Ventilation is required when gas appliances are in use. Open designated venting openings while gas appliances are in use. Never obstruct ventilation openings and ensure that gas appliances are operating correctly.**



MAREX 375

### 3.3.1 GAS INSTALLATION AND LEAKAGE TEST INSTRUCTION

**⚠ DANGER:**

**⚠ WARNING:**

#### ❖ SAFETY

The pressure gauge is designed to check current pressure in system and can be used to detect leaks in gas systems with a maximum working pressure of **200 kPa (2 bar)**. The system is supposed to be checked prior to the first use, after a period of non-use and every time the gas bottle is changed.

Propane is an explosive gas; therefore smoking and open flames are absolutely prohibited.

#### ❖ TESTING

##### **With a gauge fitted:**

1. Close appliance valve,
2. Open LPG cylinder valve,
3. Allow indicated gauge pressure to stabilize,
4. Close LPG cylinder valve,
5. Observe pressure gauge reading for 3 min, pressure gauge reading should remain constant if no leak in the LPG system is present.

The gauge does not provide an indication of liquid LPG remaining in the cylinder, only its vapour pressure, which is a constant at any given temperature.

**⚠ WARNING:**

**Do not use an installation that has leaked until it has been inspected and repaired by a competent person.**



## 3.4 ELECTRIC SYSTEM

### **⚠ DANGER:**

#### **Never:**

- ✓ work on the electrical system when the system is activated.
- ✓ change the electric installation and relevant parts. Use an authorized marine electric technician.
- ✓ change or divert the power circuits or fuses.
- ✓ install or replace electrical components with higher voltage than the system permits.
- ✓ leave the boat without attention with the electrical system activated except for the systems for the automatic lens pump, the fire protection and the alarm.
- ✓ use start-cables without spark protection/ignition protection. This can damage the electronic system for the engine!

### **⚠ DANGER:**

#### **To minimize the danger of shock and fire:**

- ✓ **Turn off the switch to the shore connection in the boat before any connection or disconnection of the cable power.**
- ✓ **Always connect**/plug the boat first and then the electric circuit on land.
- ✓ **Always disconnect**/unplug on land and then on the boat.
- ✓ Make sure that the cover of the plug is in use.
- ✓ Do not change the connections in the systems.
- ✓ Use only certified cables.
- ✓ Use grounding cables (green or green with yellow stripe) on metal covers on the 230V electric equipment.

### **⚠ DANGER:**

**Do not let the shore-connection cable fall into the water. This can cause DAMAGE AND DEATH! An electric field can be created and is a danger to life!**

### **⚠ DANGER:**

**If a shore connection is fitted, do not swim close to the boat.**

## 3.5 BATTERIES

### **⚠ WARNING:**

**By charging the batteries an explosive gas develops. Do not use open flame close to the batteries when charging them. The smell of rotten eggs is a clear indicator of a leakage.**





MAREX 375

### 3.6 ENGINE ROOM

#### **⚠ WARNING:**

- Do not enter the engine room when the engine is running.
- Stop the engine for inspection of propeller.
- Do not operate the boat with an engine of rated power greater than the maximum recommended power.

### 3.7 FUEL TANK

Fuel tank is placed in the engine compartment (under the cockpit floor). The emergency closing valve for the engine fuel feed is located under the same hatch, on the fuel tank.



Picture 9: 2 Emergency fuel closing valves – cockpit (1)

#### **⚠ WARNING:**

When the valve handle is a cross the hose, then it is closed (Figure 2 above).  
When the valve handle is placed parallel with the hose, then it is open (Fig. 2 below).

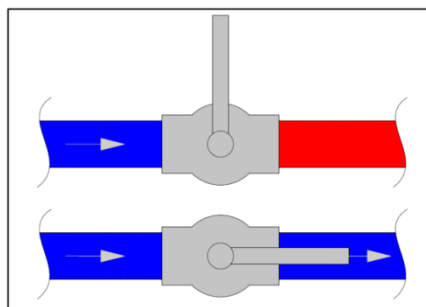

Figure 2



MAREX 375

### **⚠ CAUTION**

**Make sure that the fuel lines are always intact. The pipe should not be extremely bended, close to corners or any other sharp areas.**

- Exit the boat for filling fuel.
- Do not overfill the tank. Carefully measure the proper amount of diesel when refuelling. Leave some space in the tank to avoid spillage during normal motion of the boat.
- When refuelling, check if the fuel line has an automatic stopping device.
- Ensure that no fuel is discharged over the side or into any part of the boat.
- Regularly check that all fuel line connectors are tight.

### **(F) DANGER**

**When refuelling the tank, do not smoke. It is dangerous!**

## **3.8 THROUGH HULL LEADS - UNDER THE WATERLINE**

### **3.8.1 CLOSING VALVE – SEAWATER INLET FOR THE TOILET SYSTEM**

The seawater inlet closing valve for the automatic toilet (optional) is placed under the hallway floor in the front cabin area.



Picture 10: Location of the seawater inlet for toilet flushing (1)

### **⚠ DANGER:**

**Close the septic tank outlet BEFORE cleaning the seawater filter for the toilet.**



### 3.8.2 CLOSING VALVE – BLACKWATER OUTLET

The closing valve for Blackwater outlet is placed in the engine room.

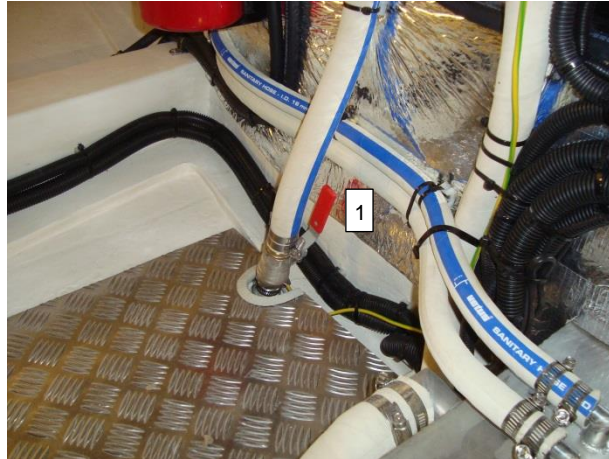

Picture 11: Location of the black water outlet and valve (1)

**⚠ WARNING:**

When the valve handle is across the hose, then it is closed (Figure 3 above).  
When the valve handle is placed parallel with the hose, then it is open (Fig. 3 below).

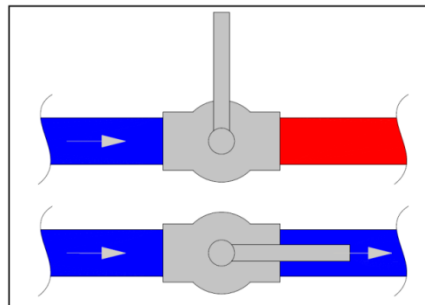

Figure 3

**⚠ WARNING:**

Check frequently for leakage. Do not leave the valve open without regular controls. It is advisable to keep the unused valves closed at all times, for prevention of eventual flooding.



### 3.8.3 CLOSING VALVE – SEAWATER INLET FOR ENGINE COOLING

Z Drive Volvo Penta propulsion systems have integrated engine cooling. In case of other engine installations, it can occur that extra seawater inlets and valves are necessary.



Picture 12: Location of seawater inlet for engine cooling and Closing valve (1) (optional)

## 3.9 STABILITY AND BUOYANCY

For the stability of the boat it is important:

- not to exceed maximum allowed number of persons on board.
- to consider maximum total load of the boat.
- not to change position of the masses (for example the radar, engine, tanks, batteries, etc.). This may significantly affect the stability and performance of the boat.
- that all standard equipment is aboard.
- to remove collected bilge water (it should be kept to a minimum).
- not to add any weight on to higher boat areas.
- to consider the design/construction category.
- to close all hatches, lockers and doorways to minimize the risk of flooding.
- not to tow or lift heavy objects using a davit or the boom.



### 3.10 SAFETY EQUIPMENT

#### **⚠ DANGER:**

- In most countries safety vests or something similar must be available for ALL passengers aboard. All of them should also know how to use such equipment.
- A Life raft canister can be placed at the bathing platform by the aft bench.
- **Rehearse on “Man overboard” and practice the easiest boarding of the boat from the water. This can save your and your family’s life.**
  - Man overboard is a situation in which a person has fallen from a boat or ship into the water and is in need of rescue.
  - Falling overboard is one of the most dangerous and life-threatening things that can happen at sea. Therefore it is really important that every person on a boat has his/her own safety vest that has been adjusted to fit him/her before leaving port.
  - Whoever sees the person's fall should shout "man overboard" to alert other crew members and attempt to maintain visual contact with the person in the water. By pointing continuously at the victim, the person can help the helmsman in approaching the victim.
  - The answer to a man overboard is never for more people either to jump over to 'help' him/her, or to fall in themselves by accident.
  - The helmsman must stop the boat immediately and try to approach the person in the water.
  - **Re-boarding of the victim can be done with use of the bathing ladder. The hatch opens into vertical position so that the bathing ladder is accessible. Flip the ladder into the water and close the hatch (see Picture 13).**



Picture 13: Bathing platform with open ladder cover





### 3.11 EMERGENCY EXITS

#### ⚠ DANGER:

Emergency exits front cabin:

- ✓ Door from front cabins to the cockpit, opening size 53 cm.
- ✓ Hatch above front cabin, opening size 55 cm.

Emergency exit salon:

- ✓ Trough main sliding door and out into every direction.

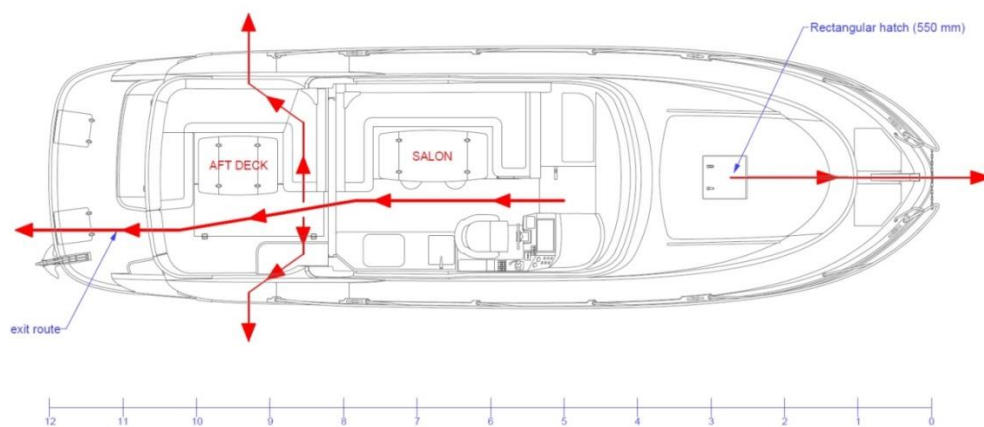

Figure 4: The emergency exit routes

### 3.12 EMERGENCY STEERING

**EMERGENCY STEERING** is possible with the use of bow thruster and in other cases also with stern thruster.

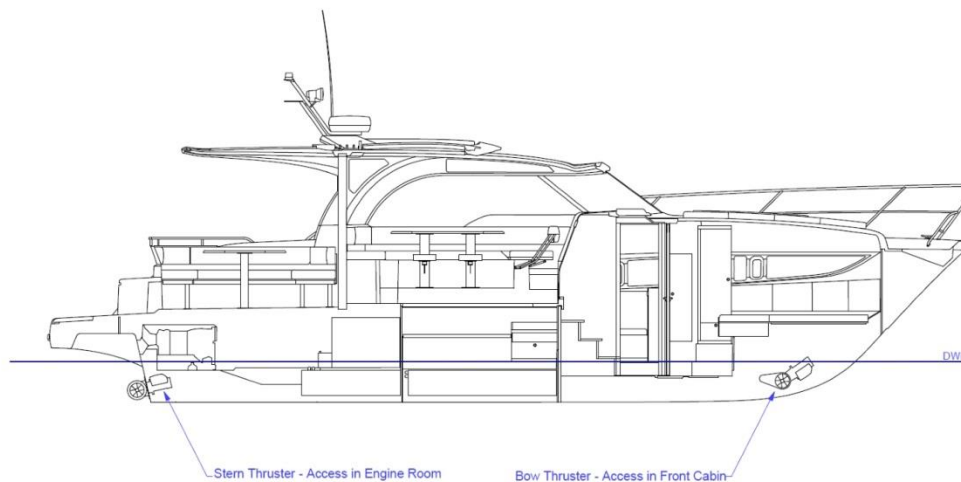

Figure 5: Emergency steering



## 4.0 DRAWINGS AND TECHNICAL DESCRIPTIONS OF THE BOAT

↗ These drawings show a standard boat.

### 4.1 ARRANGEMENT AND EXTERIOR DRAWINGS

Divider number 2 includes the following drawings:

- UM-01 Main particulars
- UM-02 General arrangement - Interior – Port side
- UM-03 General arrangement - Interior - Starboard
- UM-04 General arrangement - Interior - Top view
- UM-05 General arrangement - Exterior - Top view

### 4.2 TECHNICAL SYSTEMS

#### 4.2.1 DRAWINGS OF THE TECHNICAL SYSTEMS

Divider number 4 includes the following drawings:

- UM-06 Trough hull fittings - Top
- UM-07 Trough hull fittings - Starboard
- UM-08 Trough hull fittings – Portside
- UM-09 Deck trough fittings
- UM-10 Access hatches
- UM-11 Emergency exit routes
- UM-12 Engine room ventilation
- UM-13 Fuel system – twin diesel engines
- UM-14 Water system
- UM-15 Septic system (WC/Pump system)
- UM-16 Cockpit draining
- UM-17 Heating and Defroster outlets
- UM-18 Fire extinguishers
- UM-19 Principal drawing 12V system
- UM-20 Principal drawing 230V system
- UM-21 Main switch panel
- UM-22 Fuse panel
- UM-23 Illumination
- UM-24 Steering wheel scheme
- UM-25 Mooring and towing
- UM-26 Lifting points
- UM-27 Emergency Steering
- UM-28 Overview





## 4.2.2 PICTURES AND DESCRIPTION OF INSTALLED COMPONENTS

In divider number 7 in this owner's manual you will find pictures with descriptions of installed components in a standard Marex 375.

## 4.3 FUEL SYSTEM

The fuel system consists of one fuel tank in the engine compartment (placed under the cockpit floor) and hoses connected to the tank shown on the enclosed drawings. The tank is made of stainless steel sheet metal. For maintenance and control of this system, please contact a marine service workshop.

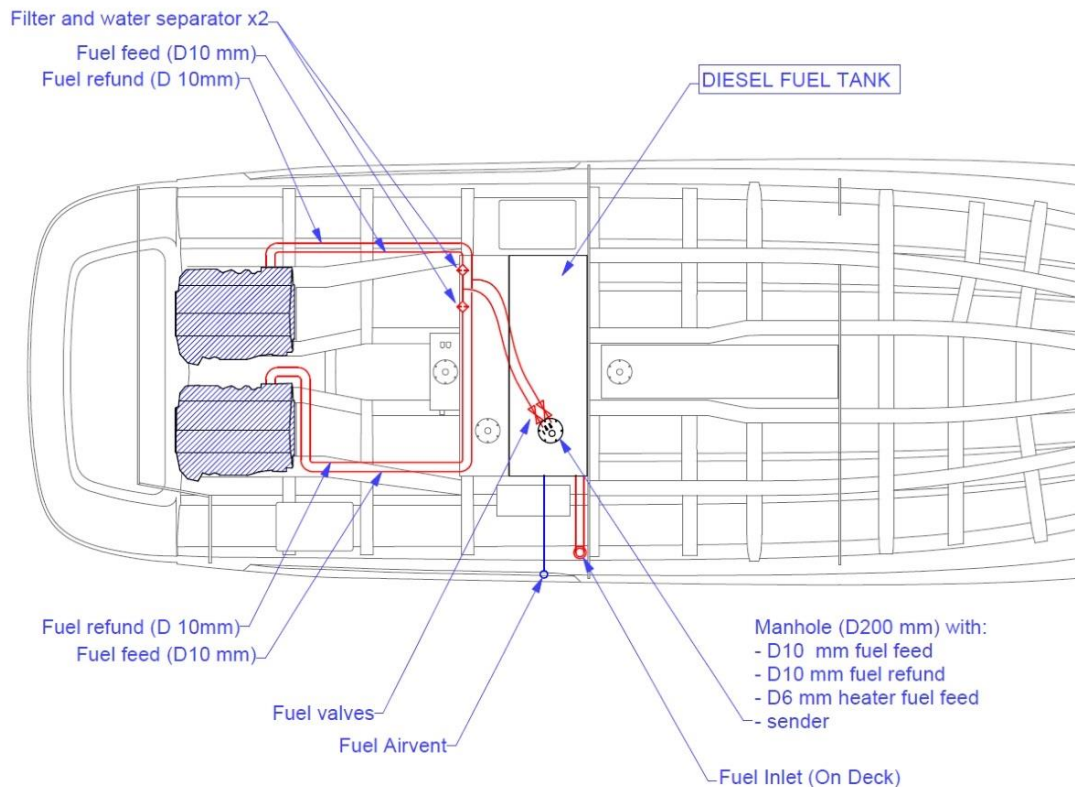

Figure 6: The fuel system (top view)



MAREX 375

Fuel closing valve is mounted above the fuel tank.

Filter/water separator in the engine room must be checked on a regular basis. If any impurities or water is discovered in the separator, you need to contact the service workshop.



Picture 14: Two diesel filters with water separators (1)

Possible errors:

- blocked tank ventilation
- closed position of the fuel valve
- the fuel filter is full of water
- the fuel filter (“fine filter”) is full,  read the user manual for the engine
- defected fuel pump on the engine
- objects in the tank that can block the internal flow



## 4.4 DRAINING SYSTEM

### Draining of the cockpit floor:

- ↗ The starboard aft deck drain is located in the starboard aft corner of the floor. It leads out through the hull fitting on the starboard side.



Picture 15: Aft deck drain on the starboard side (1)

- ↗ The port side drain is located in the aft back corner of the aft deck floor and leads out on the portside through the hull fitting.



Picture 16: Aft deck drain on the port side (1)



## 4.5 LENSING SYSTEM

### ⚠ **WARNING:**

**The bilge pumping system is not designed for damage control.**

### 4.5.1 MANUAL LENSING SYSTEM

The boat has two manual lensing pumps:

- One is placed under the hallway floor in the front cabin area (front area).
- Second manual pump is placed in the engine room (aft area).



Picture 17: Manual bilge pump for the engine room (1)

The manual lensing system pumps out the water by hand. This system is standard and is operable from within the designated area. **Stick the “pin” (a steel rod with a black handgrip) and pump up and down.** The lens pump is pumping water out of the room in the direction of the pointed arrow.

### 4.5.2 AUTOMATIC LENSING SYSTEM

### ⚠ **WARNING:**

**Automatic lens pump does not replace a visual control and it does not work if the batteries have a lower voltage than 11 Volts.**

- The automatic lensing system works for cabins, and the engine room.



Picture 18: The automatic lensing system in the engine room (1)

- The automatic lensing is connected to a switch on the dashboard.



Picture 19: Lensing lamp indicators (1)

- System is operating in automatic mode.
- Press and hold switch to run lensing pump manually.
- If pump is working automatically or the switch is pressed, then alarm will sound.

### **Possible faults:**

- The automatic fuse placed in the main switch panel must be reset (20 amp) and the red light has stopped illuminating.
- The pump inlet is blocked. This may also happen to a manual pump.





## 4.6 FRESH WATER SYSTEM

### INSTRUCTION MANUAL

- ✓ Read the user manual for the hot water tank and the pressure water pump.
- ✓ Read the user manual for the shower draining pump.

The fresh water system provides hot and cold water. Cold water comes directly from the fresh water tanks, while the hot water is provided with help of the engine heat or electrically, while the boat is plugged into the shore connection. The water is never heated with the use of service batteries.

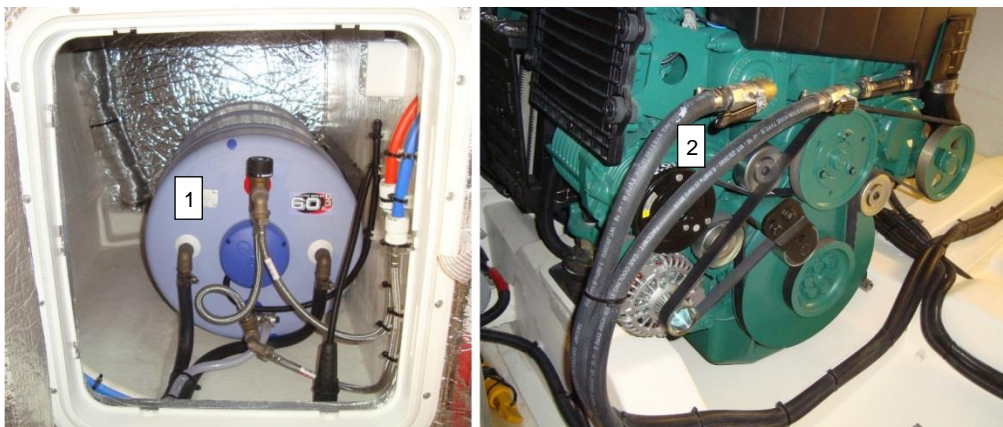

Picture 20: Water heater, placed in the engine room (1),  
Water heater heat exchange connection (2) (Volvo engine)

- ✓ Water heater **MUST NOT** operate while empty. If this happens, read the instruction manual for the water heater.



Picture 21: Fresh water pump and filter under the hallway floor (1)



Picture 22: Fresh water tank in the front cabin – under the front bed (1)

The fresh water system is used for:

- sink and shower in the toilet room
- external shower on the bathing platform
- sink in the pantry
- Windscreen washer

The system has a dedicated water pump that starts automatically, when the water pressure drops (by opening a tap).

The shower has a separate lensing pump to drain the grey water. It is controlled by a switch, located in the shower cabin.



Picture 23: Shower lensing pump (1)



Possible errors that may prevent free flow of water:

- Blocked air ventilation of the water tank.
- Blocked/full freshwater filter.
- Automatic fuse for the freshwater pump has been released. For resetting the fuse see the fuse panel placed starboard at the helmsman position (25 amp), marked "12 V CABIN". The red light is not ON if the fuse is working correctly.
- Micro-switch at the bottom of the sump box is not working correctly.
- Leakage in the system: check all hoses and fittings.
- The shower on aft bathing platform is not closed.

## 4.7 SEPTIC SYSTEM/BLACK WATER SYSTEM

The system consists of the toilet bowl and a septic tank. It operates:

1. by discharging the black water through a hull bottom valve
2. or with the suction hose emptying the tank by a stationary vacuum machine, through the deck vacuum discharge outlet, located on starboard side deck.

### INSTRUCTION MANUAL

- ✓ Read the user manual for the toilet system.



Picture 24: Toilet controls (1), ventilation (2), water level trimmer shaft (3)

When the toilet isn't used, the water level should be 1 cm above the outlet hole in the ceramic bowl. If for any reason, more or less water is wanted in the ceramic bowl, it can be adjusted by turning shaft trimmer in the rear part of the control panel, accessible through cupboard below the sink.

***Do not go to sleep, while the septic tank is full. The morning sunlight can heat up full septic tank and stinking gas will appear as a result of expansion.***





Picture 25: Black water level indicator (1) - optional  
(In combination with electrical discharge)

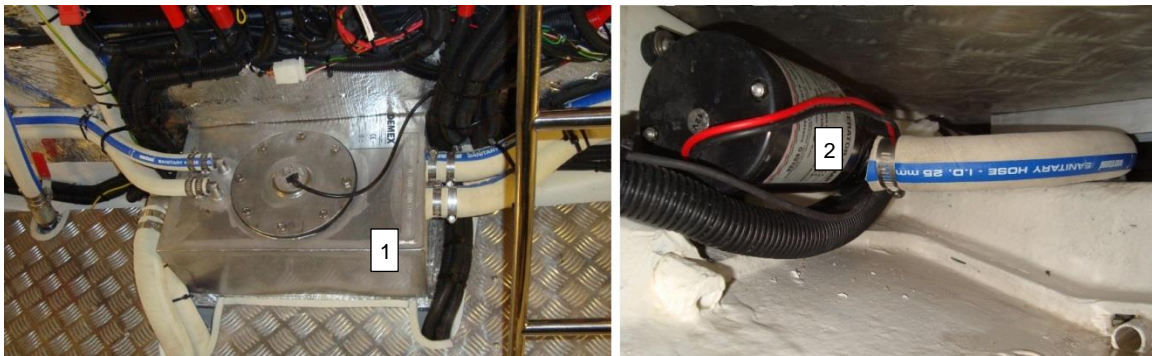

Picture 26: Septic/Black water tank in the engine room (1),  
Macerator pump - optional (2)

Possible errors that may stop or block the discharge:

❖ **No water inside the toilet bowl:**

- Blocked inlet for the water into the toilet (plastic pieces, seaweed etc.).
- Filled filter for the toilet pump.
- No power on septic flushing pump. Automatic fuse for the septic pump must be reset. It is located in the fuse panel on the starboard side (25 A), marked "TOILET". The red light in the panel will be ON if the circuit is broken.
- No power to the toilet. The fuse has to be reset.



❖ **Blocked macerator in the toilet bowl:**

- Due to a block in the hoses.
- Through use of too much or bad toilet paper.

➤ Hint:

1. Fill a plastic bottle (1.5 l) with a strong mix of dish washer detergent and water. Place the bottle upside down into the toilet and squeeze it hard to flush the toilet open.
2. Empty a strong mix of dish washer detergent and water into the toilet bowl and let the mix work for some time. Pump in water into the bowl and try to flush.
3. Demount the engine in the macerator. Remove the plastic cover, unscrew the four screws and clean. Caution: Make sure to place the rubber Simmering/Seal in the correct place, or the toilet will leak.

❖ **Blocked air vents can prevent the emptying of the toilet tank and cause bad smell:**

➤ Hint:

1. Flush some water into the air vents from the outside of the boat and into the tank. The septic can be dried up and become "composted".
2. Fill the septic tank with freshwater and sanitary liquid through the septic tank vacuum inlet on the deck (the fitting).

❖ **Discharge through the hull fitting/valve is not working correctly (macerator pump in engine room):**

- No power on the macerator pump. Reset the fuse in the fuse panel (25 A), marked "TOILET".
- Macerator pump blocked by non-dissolved paper or non-dissolved septic.

➤ Hint:

1. Close the bottom valve.
2. Demount the front of the macerator pump. Clean the plastic "fins" mounted before the pump.



## 4.8 ELECTRIC SYSTEM

The system consists of two main parts:

- 12 Volt Direct Current (DC) from the service batteries
- 230 Volt Alternating Current (AC) by the use of shore power. Be aware that you do not have unlimited power capacity. Use the power carefully and turn off the light in unused rooms.

**Voltage:** 12V DC/230V AC  
**Starter battery:** 2x100Ah (Service switch marked "START")  
**Service batteries:** 4x95Ah (Service switch marked "SERVICE")  
**Battery charger:** 230V AC

(Optional: AGM battery – starter battery 2x100 Ah, service batteries 4x95 Ah)



Picture 27: Starter batteries (1)  
Service batteries (2)

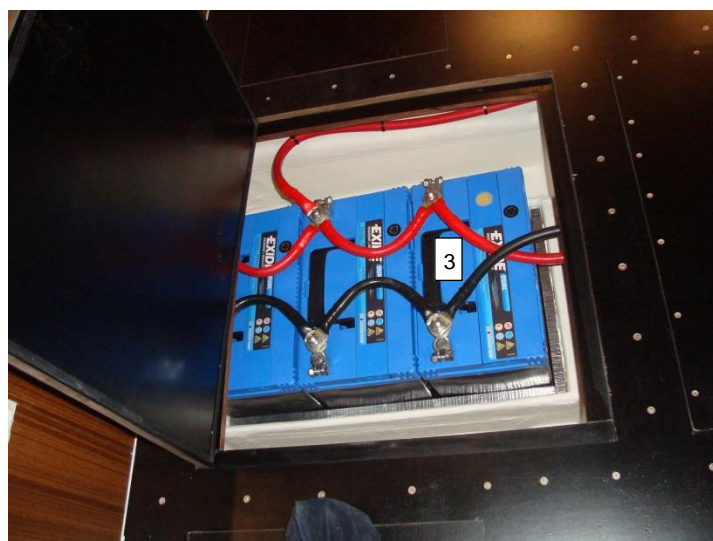

Picture 28: Service batteries (3)



Picture 29: Dual sense charging relay

#### INSTRUCTION MANUAL

Read the instruction manual for the battery charger.

#### **12 VOLT SYSTEM:**

Batteries:

- *The Starter battery serves for:*
  - Starting of the engine
  - Electronics of the engine
  
- *The Service batteries serve for:*
  - pumps
  - electronic equipment
  - cabin lights and courtesy lights
  - anchor winches
  - radio and TV
  - various service devices
  - bow thruster
  - aft thruster

#### INSTRUCTION MANUAL

See enclosed drawings of the switch panel and main switches.

#### **230 VOLT SYSTEM:**

- ✓ Using shore power service batteries are recharged first, then through charging relay starter battery is charged
- ✓ The main circuit breaker for the 230V system is 20A. It is placed on the port side in engine room in the main fuses panel.





MAREX 375



Picture 30: 230 V Main fuse 20A and grounding relay (1)  
(Lamp indicates when 230 V is active.)

## 4.9 EXHAUST SYSTEM

Is integrated into the Z drive.



Picture 31: The exhaust hose (1)



MAREX 375



Picture 32: The exhaust outlet

## 4.10 VENTILATION SYSTEM FOR THE ENGINE

The engine room is ventilated through the side openings on the hull at aft, on port and starboard side. The air travels down the sides and into the engine room.

**Do not block the ventilation area, while the engine is running!**

## 4.11 FIRE EXTINGUISHING SYSTEM

**It consists of:**

- 1 portable fire extinguisher, which is located at the sitting group.



Picture 33: Portable fire extinguisher - 2 kg capacity (1)



- 1 automatic extinguisher in the engine room with an indicator by the helmsman position.

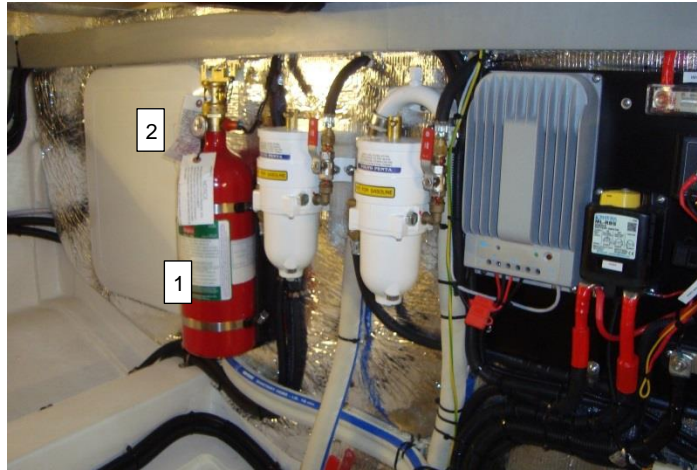

Picture 34: Automatic fire extinguisher in the engine room – 2.5 kg capacity (1), fire extinguisher volume level (2)

- 1 fire blanket



Picture 35: Fire blanket (1),  
Simple tool set for maintenance (2),  
User documentation bag (3)

Fire blanket together with other items for the boat's upkeep are placed in the sitting group in cockpit, when the boat is delivered for the first time.

**⚠ WARNING:**

It is owner's responsibility to place fire blanket to comfortable and well-known position for all crew/passengers for quick access in case of emergency





## 5.0 OPERATION

This chapter contains information advices and hints about practical use of the boat and equipment.

**The following of activities and equipment will be commented:**

- ✓ Starting the engine
- ✓ Batteries
- ✓ Switch panel
- ✓ Fuse panel
- ✓ Windscreen wipers
- ✓ Electric system
- ✓ Septic system
- ✓ Operation of the equipment in the boat
- ✓ Manoeuvring
- ✓ Hints advices and tips

The following descriptions have two intentions: to promote maximum safety and to guide you through the correct use. This will lead to long unproblematic use and good second hand value of the boat. Proper operated equipment provides safety and comfort aboard.

### **⚠ DANGER:**

**Before starting it is important to assure yourself that the safety equipment (safety vests, fire extinguisher, anchor, ropes etc.) is present and functional. Always use a safety vest aboard.**

## 5.1 STARTING OF THE ENGINE

### **📖 INSTRUCTION MANUAL**

Follow the advices of the engine supplier on starting, driving and stopping of the engine.

**Before starting check the following:**

- ✓ Control the boat for leakages over and under the waterline.
- ✓ Check that all hoses and couplings are intact.
- ✓ Turn on the main switch.
- ✓ Follow the engine's user manual.

### **⚠ DANGER:**

**Check if the bathing ladder is felt in, and not down in the water. An opened bathing ladder, can damage the propeller.**

The throttle (gas/gear regulator) must be in neutral position. For safety reasons the engine will not start in gear.



MAREX 375



Picture 36: The neutral position

### **⚠ CAUTION**

**NEVER** leave ignition **ON**. Leaving the ignition on without the engine running will drain “START” battery.

## **5.2 BATTERIES (LEAD ACCUMULATORS)**

### **❖ Generally**

Batteries are your source of energy to start the engine and to supply you with services like lanterns, lights 12 Volt system etc.

Your boat is equipped with 6 batteries. Two are for starting of the engines and 4 are for services. They are located in the midships cabin, under the bed.

To make sure that you have enough power to start the boat, there are 2 starter batteries, which separated from the service batteries. Even if the service batteries are empty, you will still have power to start the engine from the starter batteries.

If the start battery is empty, service batteries could be used to start the engine. Start and service batteries can be connected together using a crossover switch in the engine room. Switch should be used only in emergency situations and must be switched off after the engine starts.



Picture 37: Batteries crossover switch (1).

When the engine is running, the starter battery is charged by the alternator. It is important to regularly check and maintain this system.

#### ❖ Charging voltage

The voltage by maximal charging is normally around 14.2 to 14.4 V.

During charging the voltage will rise on the batteries. The battery charger automatically decides when the charging is stopped.

#### ❖ Battery voltage

The voltage on a normal battery is around 12.3 to 12.8 V (if it is unused).

**Note:** To get the correct voltage when measuring it, you must measure directly on the batteries and not on the generator.

The service and the starting batteries have a voltmeter located in the fuse box, by the helmsman position. If the voltage drops under 11.5 Volts, they can be permanently damaged.

Please note that LEAD ACID batteries will create gas at 14.4 Volt. This gas is very explosive.

**Hint:**

- The gas smells like “rotten eggs”.
- Be aware of bad smell and act quickly if gas is created.

If the battery charger is operational and well maintained, it will automatically stop charging before gas is created.

#### ⚠ CAUTION

**NEVER** turn off the main switch during the engine operation.



MAREX 375

### 5.3 FUSE PANEL & CONNECTION SCHEMES

Fuse panel is placed at starboard side at the helm position/driver's seat.



Picture 38: The fuse panel

Drawings are enclosed in divider number 4.

### 5.4 MAIN SWITCH PANEL

Main switches are located at the helmsman position, under the steering wheel.



Picture 39: Main switch panel



MAREX 375

## 5.5 WINDSCREEN WIPERS

Control switches are placed on the dashboard below the navigation.



Picture 40: Windscreen washer (1), windscreen wipers (2).

## 5.6 DASHBOARD INSTRUMENTS INSTALLATION ACCESS

All dashboard instruments can be reached from the underside, by removing of the wall panels, located in the toilet room.





MAREX 375

## 5.7 ELECTRIC SYSTEM

### 230 V Sockets:



Picture 41: 230V socket on port side in the engine room, charger (1).



Picture 42: 230V socket by the pantry – optional.



Picture 43: 230V socket in the toilet room.



Picture 44: 230V socket in the front cabin.



Picture 45: 230V socket near the sitting group.





MAREX 375



Picture 46: 230V socket in the mid-ships cabin.

**Do not use power unnecessarily and be careful, when maintaining the system.  
Do not forget to check if the connections and joints are properly fastened.**

When 230 Volt shore connection is plugged in, the red LED light is on.



Picture 47: The shore connection.

Service batteries are first to be charged from the shore power. After they reach nominal voltage, the dual sense relay will switch to charging of the starter batteries.

Engine alternators always charge the starter battery first. Only after they are full, then the dual sense relay switches on to charge the service batteries.

Otherwise battery groups are separated at all times.



MAREX 375

## 5.8 SEPTIC SYSTEM

### INSTRUCTION MANUAL

Read the user manual for the pressure pump of the toilet.

The bottom valve of the water inlet must be opened for the toilet to work.



Picture 48: Automatic toilet.

### CAUTION

After every usage, the toilet is flushed into the septic tank. When the tank is full, further flushing will lead to over pressure and eventual leakage of the system.

### DISCHARGE OF THE SEPTIC TANK BY DECK DISCHARGE:

The bottom valve **MUST** be closed before the septic is sucked up with a hose. **Water can be sucked up into the tank if the valve is not closed.**



Picture 49: Bottom valve "open" (1).



MAREX 375



Picture 50: Location of deck discharge

➤ **DISCHARGE OF THE SEPTIC TANK INTO THE SEA (through the bottom valve)** is possible with **the manual pump or the macerator pump (optional)** in the engine room. The macerator pump is controlled with a switch at the dashboard marked “WASTE”. On some models there is a red light that ignites when the pump is activated.

**⚠ CAUTION**

**Observe the discharging process until the tank is empty. The black water/septic instrument indicate the level of the tank.**

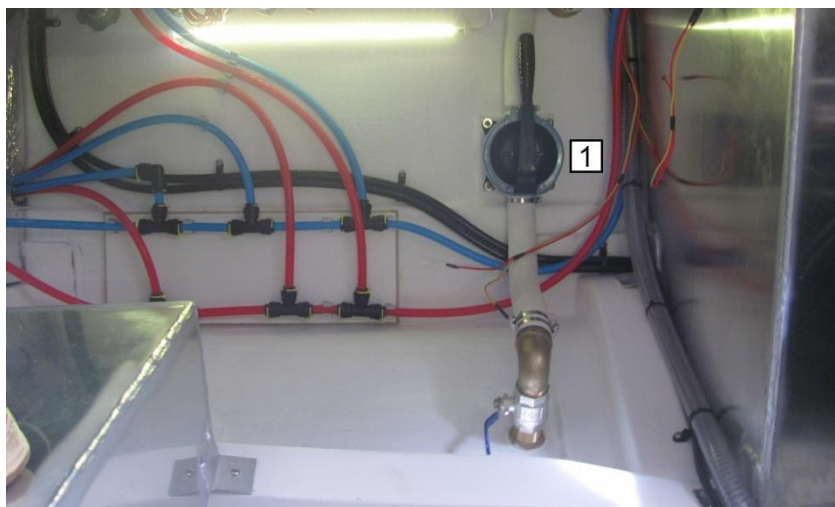

Picture 51: The septic discharge manual pump (1) – standard only



Picture 52: The macerator pump under the septic tank (1) – optional.

❖ **Hints for emptying of the black water tank:**

1. *Stop the engine.*
2. *Open the engine room hatch.*
3. *Open the bottom valve. (Picture 51: valve (2))*
4. *Discharge the tank.*

**Hint:** The sound of the macerator pump is “higher” when the tank is empty.

5. *Stop discharging.*
6. *Close the bottom valve. (Picture 51: valve (2))*

- Empty the septic tank on deep waters far away from land. Avoid polluting and respect local regulation on discharge.
- Always use approved sanitary liquids in the toilet and follow the producer’s advice.
- Always use toilet paper that dissolves in water. Normal kitchen paper **MUST NOT** be used in the toilet.
- Never place tampons, pads or cotton into the toilet.
- Inform your passengers and guests.





## 5.9 OPERATING OTHER EQUIPMENT

### 5.9.1 COOKER AND OVEN

#### INSTRUCTION MANUAL

See user manual of cooker and oven.

#### **WARNING:**

The cooker uses gas and oxygen to burn! Provide good ventilation when the device is in use. Avoid suffocation. Do not use for heating! Do not let a fender block the exhaust outlet (on the hull side) as this can cause fire.

### 5.9.2 DEFROSTER

The defroster is driven by the engine's heat and it is operated by the switch on the dashboard. It has two speeds and the outlets are in front of the dashboard, under the windscreen.



Picture 52: Defroster location in the engine room, on the starboard side (1).



### 5.9.3 DIESEL HEATER

#### INSTRUCTION MANUAL

See the diesel heater's user manual.

The diesel heater is placed in the engine room on the starboard side.

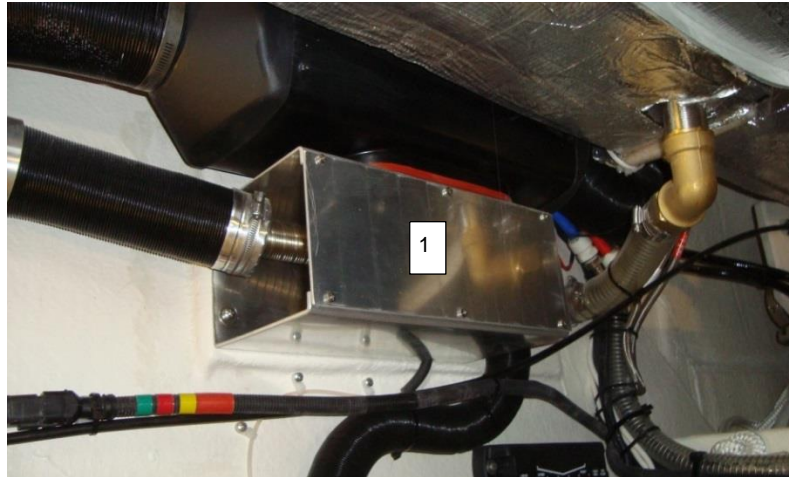

Picture 53: Diesel heater (1) with the blower.



Picture 54: The heater switch (1)

#### The heater outlets:

- ✓ 1 in the salon
- ✓ 1 on the aft deck
- ✓ 1 in toilet room
- ✓ 1 in the front cabin
- ✓ 1 in the mid cabin



### **⚠ CAUTION**

**Never close the heater outlet in the cockpit. This can cause overheating and fire. Avoid contact of materials with the heater outlets. Do not block any heater outlets with any objects.**

## **5.10 MANOEUVRING OF THE BOAT**

### **Manoeuvring of a boat, designed for category B**

Important factors to understand and study are: the boat, the cargo weight and placement, position of the Z drive, use of the trim flaps. Spend time on practicing this.

Start immediately to practice how to manoeuvre the boat with and without the bow propeller. We recommend to practice towards a buoy or another fixed point. Do not underestimate the impact of side winds.

Be advised, when the boat is exceeding hull speed of 7,5kt and approaching planning speed of 17kt on flat water, the boat is consuming much fuel and creating unwanted waves for others. Minor cavitation can occur in this area of speed and the engine is working on overload. We strongly advice to sail in slow (waterline speed) or planning speed, when you drive any planning boat.

### **❖ MANOEUVRING IN ROUGH SEAS**

Never enter rough sea unless you are absolutely positive that the boat and crew/passengers can handle it.

- Be well prepared.
- Fasten loose equipment and luggage.
- Have the emergency equipment ready.
- Close all hatches and port lights.
- Close all sliding doors.

### **⚠ WARNING:**

**Do not let children stay on open deck when sailing on rough seas. The anti-skid coating can be slippery when wet.**





MAREX 375

### ❖ **AGAINST THE WAVES**

- Adjust the speed according to the height of the waves.
- Adjust the angle towards the waves.
- Avoid waves hitting the boat sideways.



Picture 55: Sailing against the waves

### ❖ **MANOEUVRING WITH THE WAVES**

- Trim the bow high up with the tilt and trim flaps.
- Avoid sailing faster than the waves.
- Throw an emergency anchor/drift anchor if the speed is too high.

#### **⚠ WARNING:**

- **Manoeuvring possibilities are limited at high speed!**
- **Sudden manoeuvres at high speed can cause loss of control.**
- **Reduce speed before sharp turns.**



Picture 56: Manoeuvring with the waves



**⚠ WARNING:**

**Do not sit at the bow area when the boat is moving fast.**

**Do not sail the boat at maximum speed in trafficked areas or in weather conditions that can reduce the visibility. Reduce speed according to other boaters as safety precaution for you and others. Observe the speed limit and non-wave zones inside marinas etc.**

*The visibility can be reduced by a high trim angle as well as:*

- The cargo and the cargo placement
- Speed
- Quick acceleration
- Entering and exiting planning
- Sea conditions
- Rain and sea spray
- The boat's own light
- Position of the boat helms equipment and curtains

*Knowledge about weather conditions:*

- Show respect for the weather and the wind conditions.
- Observe the conditions and listen to local advices.
- Always listen to the weather forecasts.
- Always check the fuel level before any trip. By low fuel level in high seas the engine can suck air and this can cause the engine to stop.

- Always keep enough distance to avoid collisions and to manoeuvre away in case of unexpected happenings.
- Adjust the speed according to all passengers comfort. The comfort is normally perceived better for the helmsman than the passengers. Be aware of this and take care of the passengers comfort.
- Always keep the engine room closed when starting the engine.
- Do not stay at the fore deck, bathing platform or side decks during sailing.
- Close all hatches as well as the hardtop or canopy.
- Close the aft cabin door before sailing.
- Never use the bathing ladder as long as the engine is running.
- Check that the navigation lamps are working, before sailing in the dark, and always keep spare bulbs in the boat.



## 5.11 HINTS AND ADVICES

### 5.11.1 LIFTING AND STORAGE IN A “CRADLE”

Adjust the lifting straps so that the boat is lifted in a horizontal position. Use protection between the straps and the boat.

*Placing of the lifting straps:*

- ✓ Like shown on the figure 7.

*Placing the “cradle”:*

- ✓ Near the lifting straps.

*Placing of the support for storage:*

- ✓ Like shown on the figure 8.

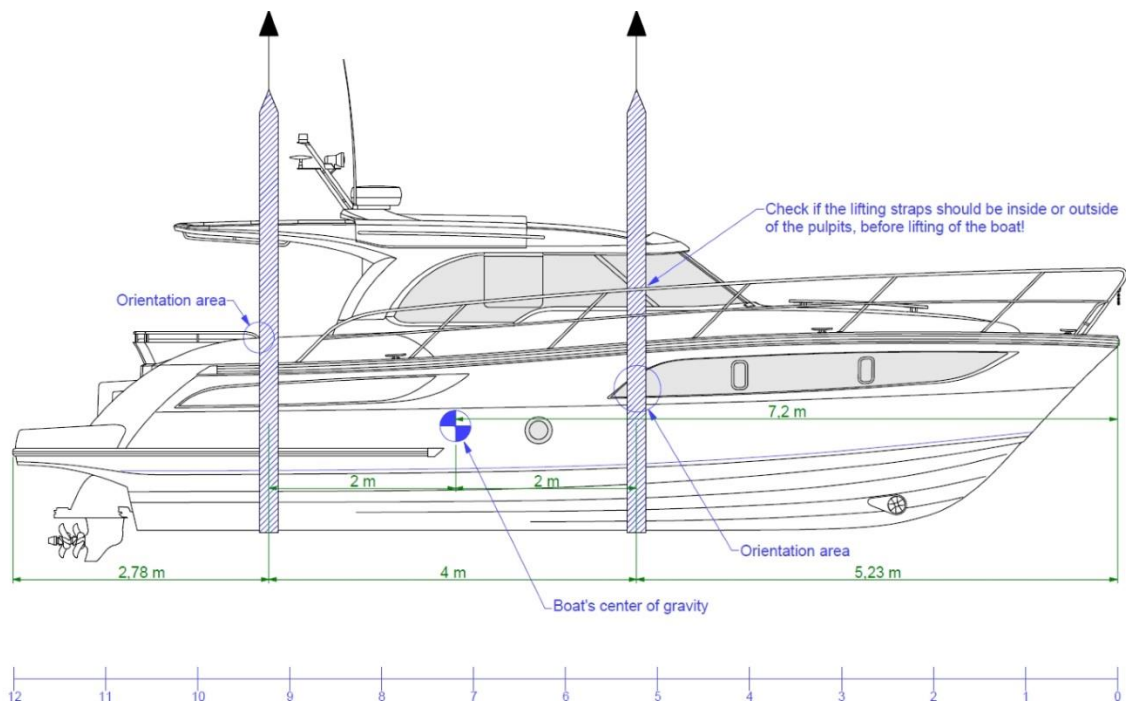
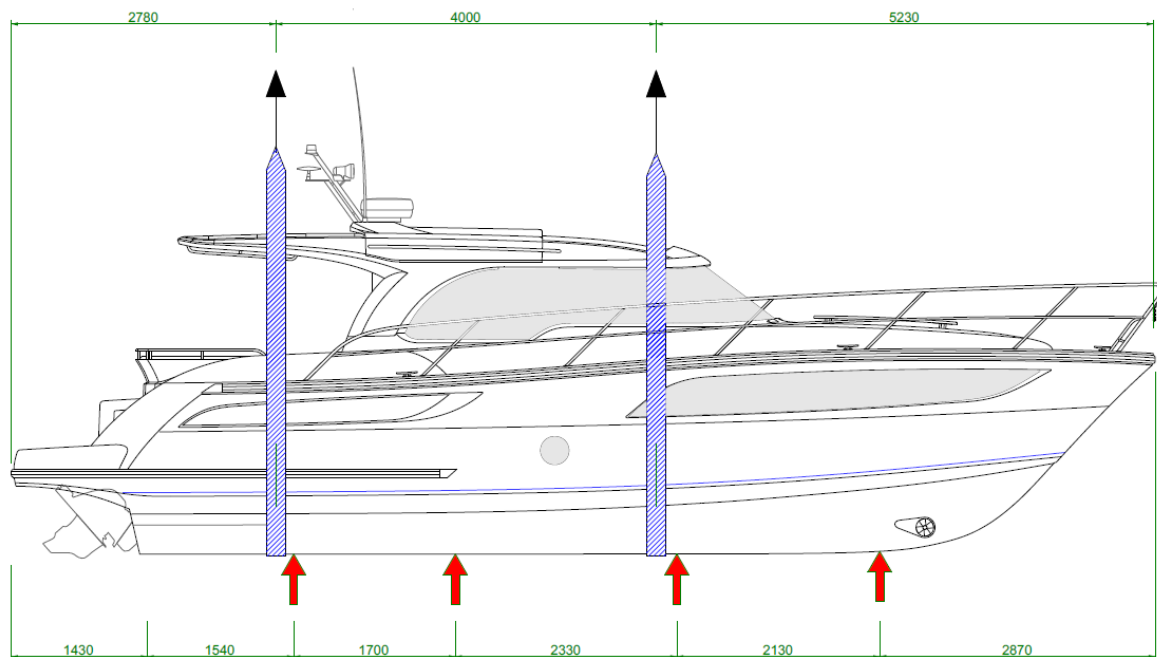

Figure 7: Place of the lifting straps

**⚠ WARNING:**  
**DO NOT STAND UNDER THE BOAT WHEN IT IS LIFTED!**



MAREX 375



Boat Weight Conditions: -  
Empty boat = 7400 kg  
Medium load = 8600 kg  
Fully loaded boat = 9800 kg  
MAXIMUM BEAM OF THE BOAT = 3.49 m

SUPPORT POSITIONS

Figure 8: Place of the storage support

### 5.11.2 BOAT TRANSPORT

- When the boat is transported on a trailer, the weight of the boat must rest on a surface on the bottom “keel”.
- Adjust the side support to avoid dislocation and fasten the boat safely.
- Make sure there is no cargo in the boat.

#### **⚠ WARNING:**

**Use a trailer suitable for the boats length and weight.**

### 5.11.3 BOAT MOORING

Marex 375 has 2 pullers in the front, 4 at the aft of the boat and 2 pullers at the mid-ship area.



MAREX 375

### 5.11.4 BOAT ANCHORING

There are two possible “strong points” at the front and/or aft anchor (depends on boat version).

- Recommended anchor weight is 15-25 kg.
- Recommended anchor rope diameter is 14-16 mm and length approx. 30-50 meters.

### 5.11.5 TOWING AND BEING TOWED

You can tow another boat or being towed. Consider that your boat has two “strong points” in the front and four “strong points” at the back (on each side of the boat are two pullers).

#### CAUTION

**Always tow or be towed at a slow speed. Never exceed the hull speed of a displacement craft when being towed.**

**A tow line shall always be made fast in such a way that it can be released when under load.**





## 6.0 PERIODIC MAINTENANCE

The maintenance of the boat and equipment should be performed by authorized personnel.

### 6.1 MAINTENANCE OF THE HULL

#### 6.1.1 BEFORE PLACING THE BOAT ON WATER

Your boat is exposed to sun, wind and water. Over time this will make the gelcoat mat. It is therefore important to wax the boat before it is placed on water. You may wax more than once per season.

If the boat has scratches or other damages in the gelcoat, those damages should be repaired. It is important that the correct gelcoat is used for this repair. This job is complicated and we recommend you to use a specialist for the best result.

If the boat gets yellow spots this can be form-wax from the production of the boat and is very common and difficult to avoid. This wax can be removed in warm weather with a thinner and very hot water.

**To protect the hull and to prevent osmosis, Marex recommends priming the hull under the waterline before antifouling is added.** This has already been made if antifouling has been ordered as extra equipment.

- ✓ Sand the underwater surface with sandpaper grade 400.
- ✓ Clean the surface and dry.
- ✓ Apply 2 layers of 2-component epoxy primer or similar product according to the producer's specification.
- ✓ Apply antifouling.
- ✓ Do not paint on the Zinc anodes.

#### **⚠ CAUTION**

Use a different antifouling on the propulsion components, intended for this purpose.

#### 6.1.2 BEFORE WINTER STORAGE

Clean the boat thoroughly after lifting it out of the water. Remove all fouling and apply a thin layer of wax or Vaseline over the boat. This will ease the maintenance next year. Spray all electrical contacts with anticorrosion spray, suitable for electrical equipment.



MAREX 375

### 6.1.3 NORMAL MAINTENANCE

Remember that a well-kept boat has a higher second hand value. Oil and grease can leave permanent stains. If you need to rub and polish the boat it is important to wax it.

## 6.2 MAINTENANCE OF THE TEAK DECK

The deck supplier recommends that the boat owner tests and uses those products that give the best result. The wood must first be well cleaned with soap and water. Do not use a hard brush. Do not use high pressured water. The wood must be totally dry before fat/grease/oil is applied. This will give the teak its colour but many boaters prefer the teak to go grey.

The deck should never be exposed to acid-based detergents. Acid-based detergents will damage teak seams irreparably.

There are many products on the market and Marex recommends oiling the deck with oil without chemical additives. To get the best result the teak can be sanded with fine sandpaper and then oiled.

## 6.3 MAINTENANCE OF THE ENGINE AND THE DRIVE

### INSTRUCTION MANUAL

**Read the engine's user manual!**

- Control the oil level on engine and drive often.
- Control the seawater filter every 25 engine hours.
- Ensure that the flow of cooling water is continuous.
- For periodic control and replacements see the engine manual.
- Control the fuel system for visual leakage.
- Regularly check that boat fuel line connectors are tight.

## 6.4 MAINTENANCE OF THE STEERING SYSTEM

- Control the couplings, hoses, bearings and fastening points.
- Control the fluid level in the steering system frequently. Check the cylinders and hoses for leakages. Lubricate the joints and couplings with the prescribed grease/oil.
- In case of leakage, contact the supplier.



## 6.5 MAINTENANCE AND CONTROLLING OF THE ELECTRIC SYSTEM

### **⚠ DANGER:**

**When the boat is connected to the shore power, the ZINC anodes must be controlled often.** If the anodes are damaged or filled with “holes” there can be something wrong with the shore power system or the marina electric system or any other near boat or a close electrical system. Disconnect immediately and do not connect until the source is found.

### **⚠ DANGER:**

- **Clean the battery surfaces on a regular basis to prevent short - circuits.**
- Check if the ventilation holes are open, so that gas can exit. (Starter battery or service batteries are “gel” batteries and need no ventilation.)
- The battery poles and the cable shoes must also be kept clean and greased with acid free fat / Vaseline to prevent corrosion.

### **Fluid level in the cells (does not apply to GEL batteries):**

Control the levels by opening the plugs on the batteries. It should be at least 5 mm over the plates. If the level is too low, fill it up with distilled water. Do not use water from the tap. It contains minerals or pollution and can harm the batteries.

### **⚠ DANGER:**

**Do not use open fire when you control the liquid level.** The gas that develops during recharge is explosive. You can smell it. It smells like “rotten eggs”. Do not use open fire if you smell something strange or similar to this, until the cause is known or found.

### **Possible errors:**

See enclosed user manual from the battery supplier.



## 6.6 MAINTENANCE OF THE GAS SYSTEM

### INSTRUCTION MANUAL

Read the gas system's user manual.

- Test the gas system for leakages at a regular basis. Check all connections by:
  - Testing and observing the bubble-leakage-tester in the compartment on the bathing platform.
  - Manually test the system by adding soap and water to valves. Make sure the cooker valve is closed and the gas bottle valve is open. Look for bubbles.

### **DANGER:**

If you discover any leakage, close the system and immediately release the gas bottle valve (the pressure reduction valve) and make sure an authorized person repairs the system before you use it further.

- The pressure reduction valve must be controlled often and should be replaced every year.



Picture 57: Gas bottle - the pressure reduction valve (1),  
test button (2)

- Gas system hoses must be controlled at a regular basis minimum once per year. Change immediately if any hose is damaged or worn out.



MAREX 375

## 6.7 MAINTENANCE OF THE FUEL SYSTEM

- Regularly check fuel filters in the fuel tank and clean or replace if necessary.
  - Disconnect all hoses from fuel tank hatch.
  - Unscrew hatch nuts.
  - Carefully take out hatch with filters.
  - To clean filters, we do recommend acetone, white spirit or special cleaners like carburetor cleaner or etc.



Picture 58: Fuel filters in fuel tank.





## 6.8 MAINTENANCE OF THE LENSING SYSTEM

### INSTRUCTION MANUAL

- SAFETY PRECAUTION – Check the function of all lensing pumps at regular intervals. **Pump inlets have to be clear from debris and garbage.** If seacocks are fitted in the fore and aft peak bulkheads, they shall be kept closed and shall only be opened to let water drain into the main bilges.



Picture 59: Pump inlet in the engine room (1)



Picture 60: Pump inlet in the front cabin area (1)



## 6.9 MAINTENANCE OF THE FIRE EXTINGUISHERS

### INSTRUCTION MANUAL

Read fire extinguishers' user manual.

- Always check that the pressure is correct at the manometer. The indicator must be in the green zone. Contact a professional for maintenance.
- All fire extinguishers must be controlled one time per year by qualified personnel.

## 6.10 MAINTENANCE OF THE FRESH WATER TANKS

- The fresh water filter should be controlled and cleaned at a regular basis minimum twice per year. A full water filter gives a poor water flow.
- Check periodically for probable calcification of the water system.

### CAUTION

**The switch in the low end of the shower sump box will be damaged by frozen water. The switch must be controlled and eventually demounted and tapped for water.**

- If hot water starts smell bad, water heater anode must be checked. Anode is used to prevent water heater tank from corrosion and must be checked regularly. It can be found inside the water heater tank near the heating element. Anode can be checked visually and if it looks very corroded when removed, must be changed. Also, must be noted that only hot water smells bad when the anode is bad.

## 6.11 MAINTENANCE OF THE FENDER LIST

- The fender list should never be exposed to acetone or other similar solvents. To clean vinyl surfaces, like rubbing strakes, fenders etc., we do recommend abrasive cleaners for maritime use.



## 7.0 PREPARING FOR THE SEASON

### 7.1 GENERAL PREPARATION

- ✓ Take off the canopy in due time and ventilate the boat thoroughly before the boat is placed on water. Wash and polish the boat. Apply antifouling under the waterline.
- ✓ Replace the batteries and refill the water level. Check/measure the capacities, cables and cable shoes. Check the hoses and other joints. Control that the instruments and navigation lights are functioning.
- ✓ Check that all valves in the hull are working and that the hoses are properly fastened.
- ✓ Check that all filters are airtight:
  - fresh water filter
  - shower pump filter
  - toilet water inlet
- ✓ Close all draining plugs. Check that bottom valves for seawater cooling is open. Check that pipes and water taps are closed.

Adjustments on the engine feet/fundaments must only be performed by authorized personnel. The bolts are glued to the fundaments. By any adjustments you will damage the glue. If the feet/bolts are loose, contact a serviceman immediately.

#### **CAUTION**

**Check for potential frost damages.**

### 7.2 PREPARING THE ENGINE AND THE DRIVE

- ✓ Control the new oil level (the oil must be changed). See the engine's user manual.
- ✓ Control the drives new oil level (the oil must be changed). See the drives user manual.
- ✓ Control the fuel filter and change it if necessary. Control the fuel system and fasten all couplings and fittings. Check the water separator. Look for any damages or leakages or potential hazard. See the engine's user manual.
- ✓ Check the through hull fittings. Control all couplings and fittings.
- ✓ Check the propeller.

### 7.3 PREPARING THE STEERING



MAREX 375

- ✓ Check the steering function before the boat is placed on water.

## 7.4 OTHER EQUIPMENT

- ✓ Cleaning the canopy: See the supplier's manual in divider number 4.
- ✓ Clean all textiles according to the manuals.

## 7.5 REMOVING RUST/CORROSION

The only steel usable for boat is acid proof stainless steel AISI 316 L. Bolts, screws and other stainless steel parts are made from A4 quality stainless steel.

Stainless steel is not maintenance free and should be polished together with the boat. Use a soft tissue and a small brush like a toothbrush to remove dust. **DO NOT USE RUBBING materials on stainless steel.**

Rust marks on screw-heads, rails, cleats or especially on anchors are normal. It is not rust or corrosion but discoloration. This comes from mounting tools, dust, iron particles and similar. This discoloration can easily be removed by polishing with "autosol Wurth" or other similar polishing liquids.



## 8.0 WINTER STORAGE PREPARATION

- If the boat is covered with plastic, it is important to protect all surfaces against rubbing and tearing through the winter. It is a big risk that this will go mat, if it is unprotected. Use masking tape or similar to protect gelcoat, glass and steel.
- Empty the windscreen water system.

### 8.1 BATTERIES

The batteries can be kept in the boat during the winter, although it is not recommended. If you leave them in the boat then it is important that the batteries are fully charged and maintained during the winter to compensate the self-discharge that will happen. If the batteries are kept in the boat, it is also important to disconnect the PLUS cable (the red one) and prevent contact with electrical cables and the battery cable shoe.

#### **⚠ DANGER:**

**If the batteries are connected to a maintenance charger that is connected to a grounded outlet, the boat is in big risk of galvanic corrosion due to grounding errors between the boat grounding (z-drive or shaft) and the land grounding.**

#### **⚠ CAUTION**

**To prevent damage to the hot water tank, disconnect the 220V system when the hot water tank is empty. Pull out the plug.**

### 8.2 HULL

- Clean the boat while it is still in the water. Scrub all spots on deck and at the waterline. Use a boat shampoo.
- Control all through hull fittings.
- To save work it is recommended to polish the boat before the winter.
- Clean all dust and dirt to prevent a bad smell the next season.
- Remove all personal belongings to prevent mildew.
- Place 1-2 moist removers that attract moist and condense. Drain these periodically through the storage period.

### 8.3 STEERING SYSTEM

- See the enclosed steering system supplier's user manual.
- Control all nuts, joints and through hull leads. Look for damages.
- Control all fittings, hoses and bearings.
- Control the steering fluid in the hydraulics system. Refill if necessary.





## 8.4 SEPTIC SYSTEM

**The system should be empty during storage at freezing temperatures.**

- Empty the toilet bowl and septic tank/blackwater tank for contents BEFORE lifting the boat out of the water and refill one time with water before emptying again. Fill with mixed anti-freeze.
- Use anti-freeze in the toilet and pump it through (use anti-freeze mixed with water, pure anti-freeze can damage the seals).
- Control all hoses and couplings. Retighten the hose clamps. Keep all valves open.
- Demount all hoses from all filters and pumps.  
Drain the filter for the toilet water inlet.

### **⚠ CAUTION**

**Always mix anti-freeze with water. Pure anti-freeze will damage the system.**

## 8.5 FRESHWATER SYSTEM

**The freshwater system must be completely drained if the boat is exposed to freezing temperature.**

- Open all valves including the aft shower.
- Open all taps and run until empty.
- Close the pantry pump when the system only delivers air.
- Let all taps be open during the winter.
- Take off the shower handgrips.
- Empty the water tanks.
- Empty the hot water tank through the opening valve on the tank.
- Demount all hoses from all filters and pumps.
- Drain all filters:
  - fresh water filter
  - filter for the shower pump

### **⚠ CAUTION**

**The switch in the low end of the shower sump box will be damaged by frozen water. The switch must be controlled and eventually demounted and tapped for water.**

## 8.6 ENGINE AND DRIVE

- See the enclosed engine's and drive supplier's user manual.



## 9.0 ENVIRONMENTAL ISSUES

The boat owner is responsible for following local environment laws and to reduce pollution caused by:

- ✓ fuel and oil
  - ✓ garbage
  - ✓ noise
  - ✓ waves
  - ✓ exhaust
  - ✓ septic/black water
  - ✓ chemicals and antifouling
- 
- Ensure that bilge water is clean before pumping out.
  - **The risk of pollution from the boat is increased during refuelling, servicing or bilge pumping.** When refuelling, be careful not to overfill the tank. If oil/fuel is spilled, remove it instantly using an absorbent sheet or pad. Always keep a small quantity of oil/fuel absorbent material on the boat for instant use if needed. Never use detergents or emulsifiers to deal with oil/fuel spills.
  - Do not discharge toilets or holding tanks close to shore or in any prohibited zone. Use harbour or marina pump-out facilities to empty the holding tank before leaving the harbour.
  - Be encouraged to use environmentally compatible products in the operation and maintenance of the boat.
  - Prevent and discourage hull cleaning or any other underwater process that is likely to remove anti-fouling or any other deleterious material to the marine environment.
  - Use low or non-phosphate soaps.
  - Wipe cooking utensils and plates clean with a paper towel before washing-up.
  - Collect all your rubbish on board and dispose it properly ashore (including cigarette butts).

**Be aware of international regulations against marine pollution (Marpol) and respect them as much as possible.**



# 10.0 POSITIONS OF THROUGH HULL AND DECK FITTINGS

## 10.1 STARBOARD SIDE

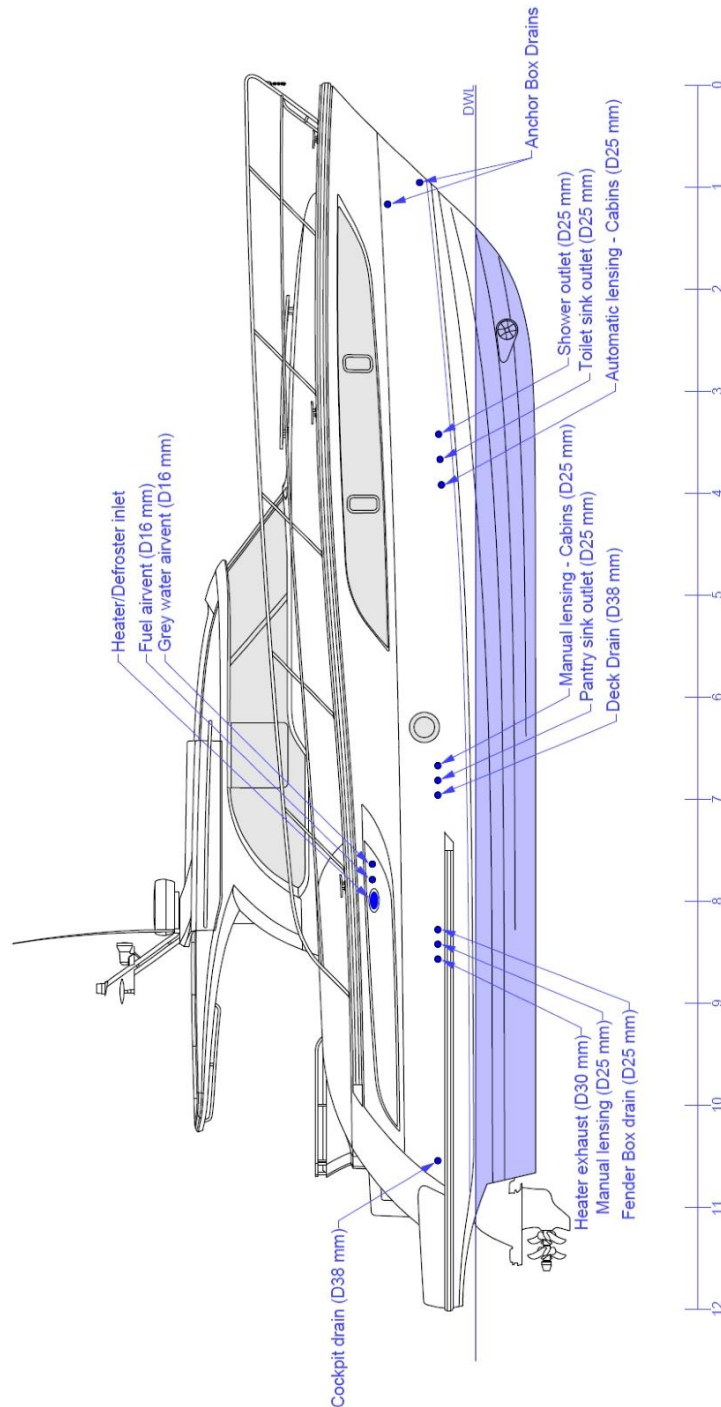

Figure 9: Starboard side.



## 10.2 PORT SIDE

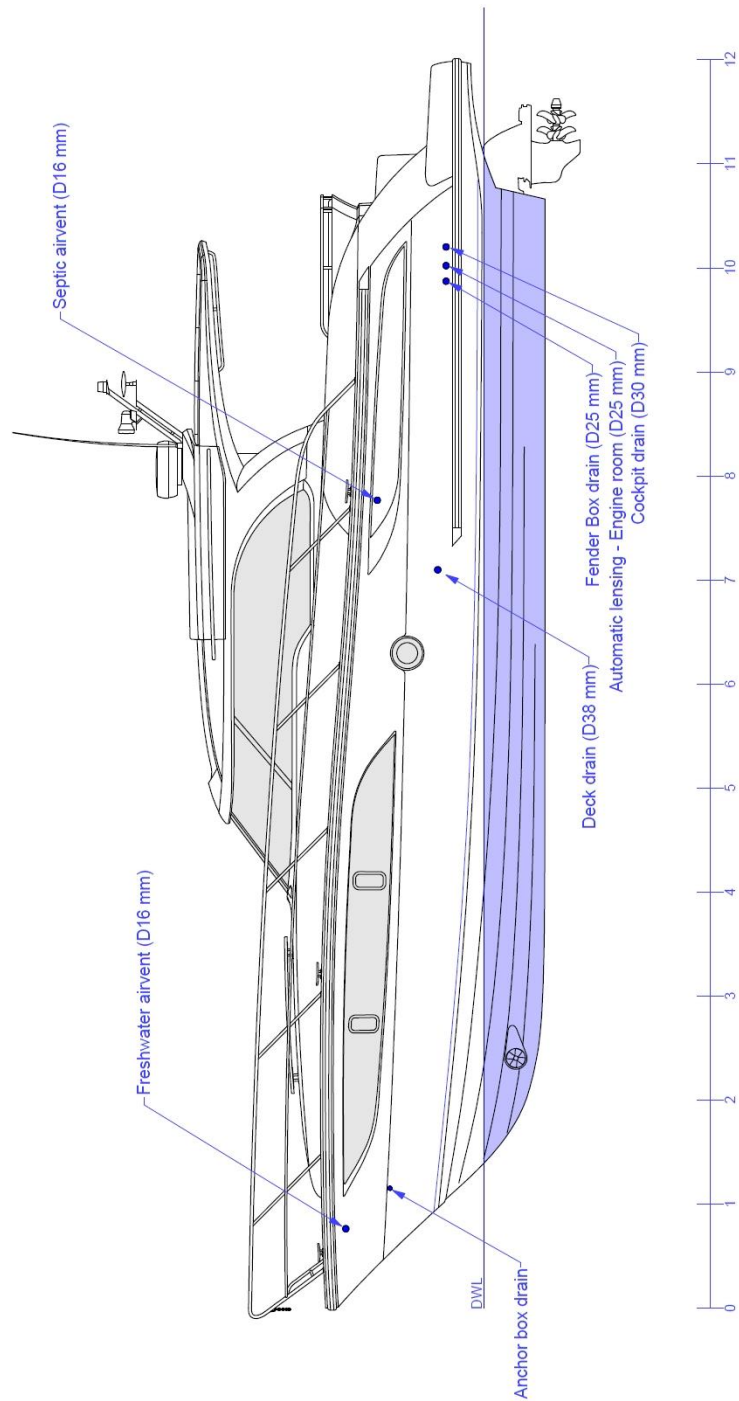

Figure 10: Port side.



MAREX 375

### 10.3 TOP VIEW - HULL BOTTOM

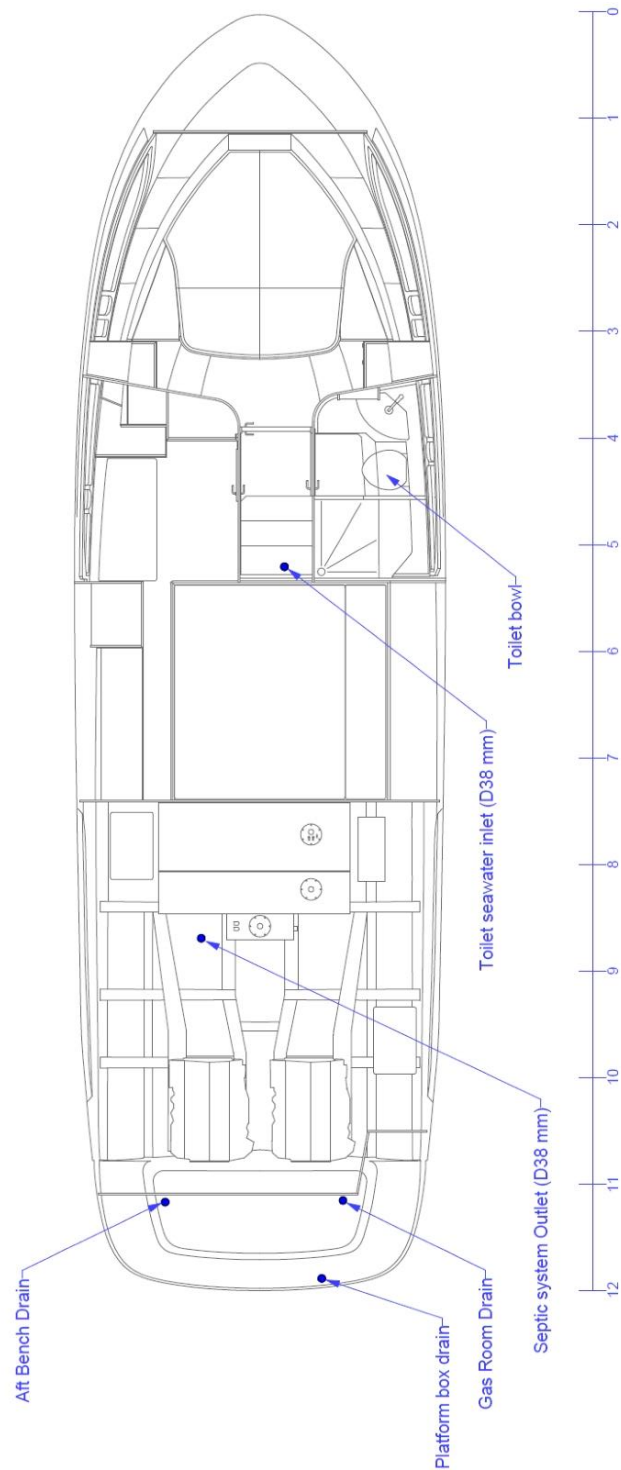

Figure 11: Top view



MAREX 375

## 10.4 TOP VIEW – DECK

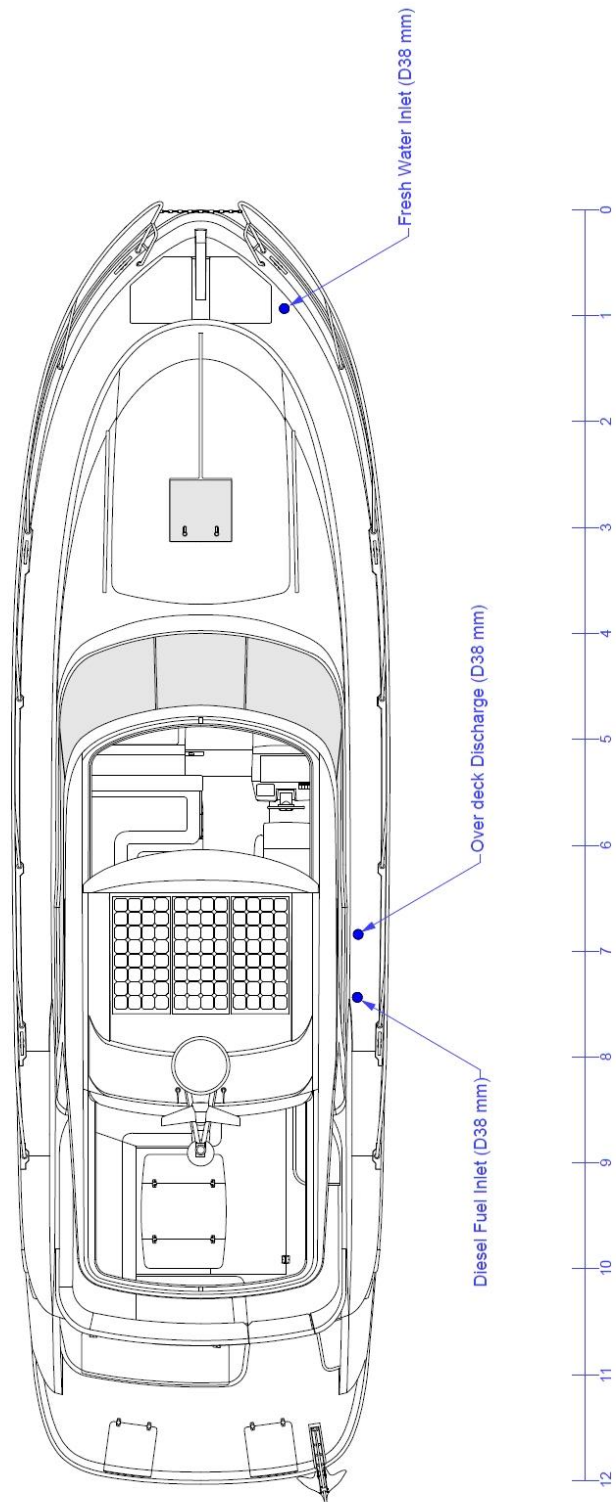

Figure 12: Deck top view





## 11.0 OVERVIEW

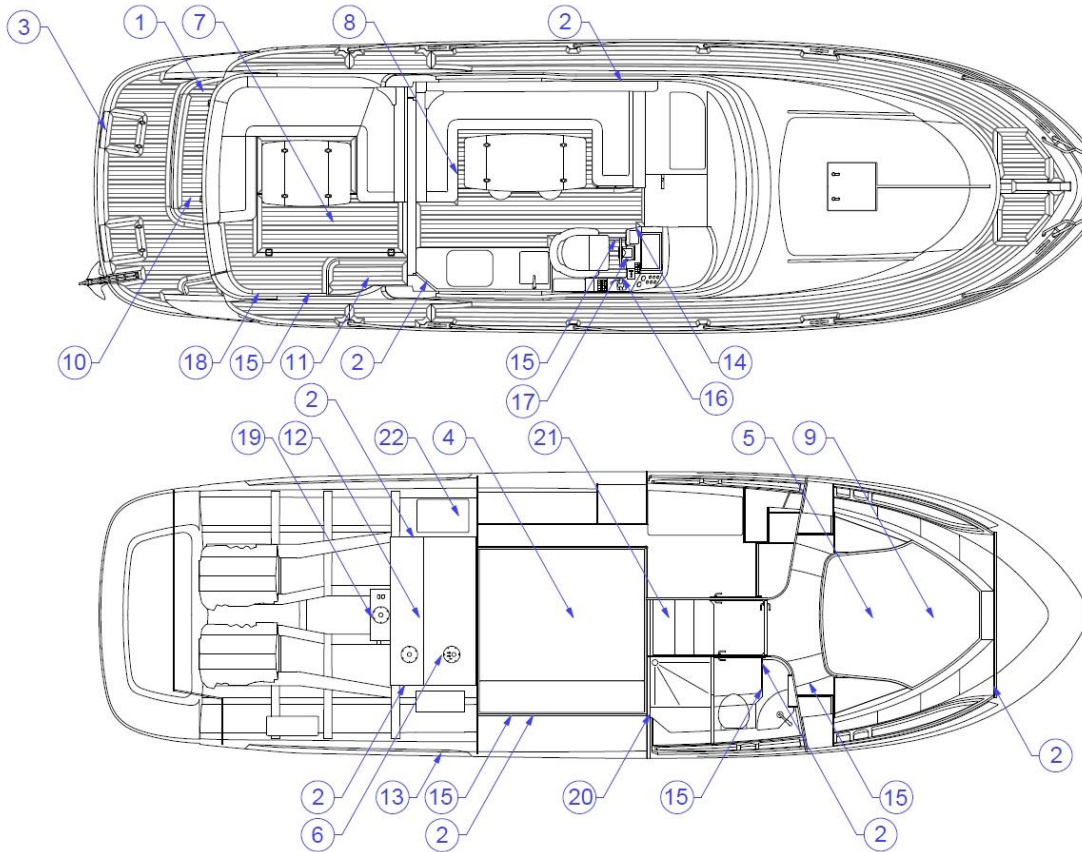

Figure 13: Overview

**Tags in alphabetical order:**

1. 230 V Shore connection plug
2. 230 V Sockets
3. Bathing ladder
4. Batteries (under amidships cabin bed)
5. Bow propeller (under the front bed)
6. Diesel fuel tank
7. Engine hatch (access to fuel, grey and septic tank)
8. Fire extinguisher
9. Fresh water tank (under the front bed)
10. Gas bottle
11. Gas closing valves
12. Grey water tank
13. Heater exhaust
14. Heater switch panel
15. Heating outlets
16. Main fuse panel
17. Main switch panel (under the steering wheel)
18. Manual lensing pump
19. Septic tank
20. Shower and bathroom fan switch
21. Toilet water inlet closing valve
22. Water heater



## ANNEX 1: A CHECKLIST OF ALL NECESSARY ACTIONS BEFORE USE

Most boating problems and accidents can be prevented, and it is important to find and correct any issues before you leave mooring. You can make your own checklist, choosing the items from the following list. Keep a copy on the boat and quickly run through the list.

Check the forecast and local wind and wave conditions.	
Tell someone where you are going and when you will be back.	
If you have guests, prepare them: appropriate clothing and gear, seasickness prevention, etc.	
Disconnect and stow away dock power and water lines.	
Smell around the boat for any suspicious fumes.	
Check the engine: fuel and oil.	
Inspect hoses, look for loose wiring, etc.	
Check the bilges for fluids or leaks.	
Open seacock for engine water intake.	
Run the ventilation in engine room.	
Check if there is all safety equipment on board.	
Check fire extinguishers, flares, first-aid kit, etc.	
Check engine cooling water outflow.	
Open other seacocks (head, sinks, etc.).	
Check navigation lights.	
Turn on the VHF and check the forecast again.	
If you have new guests, show them around and talk with them about what to do in an emergency, how to put on safety vests...	
Stow personal items and gear out of the way.	
Tune the VHF to channel 16.	
Turn on and test other electronics: chart plotter, radar, etc.	
If you have guests, make sure they are comfortably seated.	



## ANNEX 2: A CHECKLIST OF ALL NECESSARY ACTIONS AFTER THE WINTER STORAGE

You can add your own comments and make a copy for next year.

Wash and polish the boat. Apply antifouling under the waterline.	
Check that all valves in the hull are working and that the hoses are properly fastened.	
Check the through hull fitting at the shaft and its oil level. Control all couplings and fittings.	
Check the engine feet (Adjustments on the engine feet/fundaments must only be performed by authorized personnel!).	
Check the fuel system (fuel fittings and hoses – replace if necessary).	
Control the new oil level (the oil must be changed; creamy brown or gray engine or drive oil has water in it – call a mechanic).	
Control the new gear oil level (the oil must be changed).	
Control the fuel filter and change it if necessary.	
Control the fuel system and fasten all couplings and fittings.	
Check the water separator.	
Check that bottom valves for seawater cooling is open.	
Check/measure the capacities, cables and cable shoes	
Check for potential frost damages: 1. inspect non-metallic through-hulls - they can get brittle and winter ice can crack or loosen them. 2. look for hoses that have been forced off or split from freezing.	
Look for any damages or leakages or potential hazard.	
Close all draining plugs.	
Check that all filters are airtight (freshwater filter, shower pump filter, toilet water inlet).	
Check that pipes and water taps are closed.	
Check the hoses and other joints.	
Replace the batteries and refill the water level.	
Check the propeller, the propeller nut and the splint pin.	
Check the steering function before the boat is placed on water.	
Inspect anchor.	
Take off the canopy and ventilate the boat thoroughly.	
Clean the canopy.	
Clean all textiles according to the manuals.	
Stainless steel is not maintenance free and should be polished together with the boat.	
Control that the instruments and navigation lights are functioning.	





MAREX 375



MAREX 375

# *Notes*





MAREX 375

*Notes*